

ProArt

PA32USD

USER GUIDE

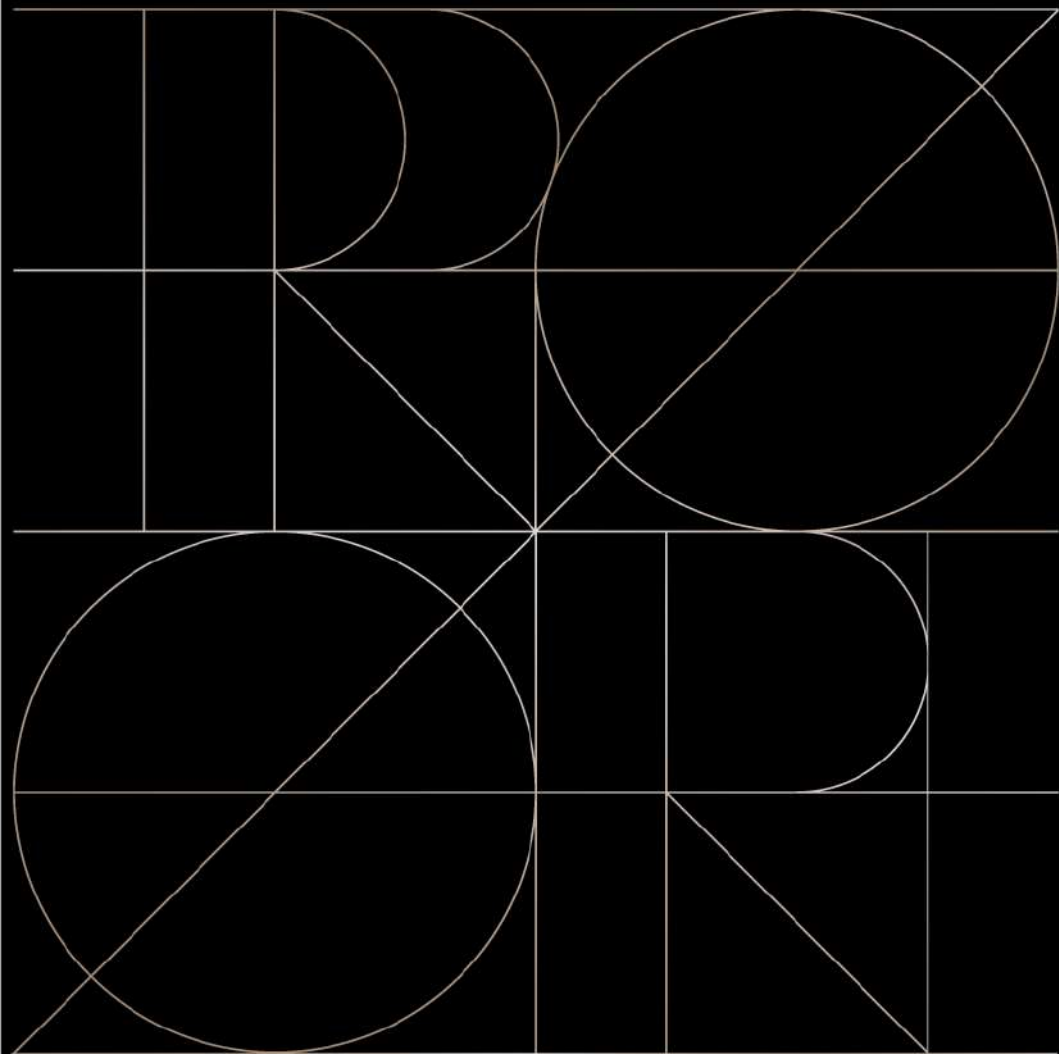

First Edition

March 2026

Copyright © 2026 ASUSTeK COMPUTER INC. All Rights Reserved.

No part of this manual, including the products and software described in it, may be reproduced, transmitted, transcribed, stored in a retrieval system, or translated into any language in any form or by any means, except documentation kept by the purchaser for backup purposes, without the express written permission of ASUSTeK COMPUTER INC. ("ASUS").

Product warranty or service will not be extended if: (1) the product is repaired, modified or altered, unless such repair, modification or alteration is authorized in writing by ASUS; or (2) the serial number of the product is defaced or missing.

ASUS PROVIDES THIS MANUAL "AS IS" WITHOUT WARRANTY OF ANY KIND, EITHER EXPRESS OR IMPLIED, INCLUDING BUT NOT LIMITED TO THE IMPLIED WARRANTIES OR CONDITIONS OF MERCHANTABILITY OR FITNESS FOR A PARTICULAR PURPOSE. IN NO EVENT SHALL ASUS, ITS DIRECTORS, OFFICERS, EMPLOYEES OR AGENTS BE LIABLE FOR ANY INDIRECT, SPECIAL, INCIDENTAL, OR CONSEQUENTIAL DAMAGES (INCLUDING DAMAGES FOR LOSS OF PROFITS, LOSS OF BUSINESS, LOSS OF USE OR DATA, INTERRUPTION OF BUSINESS AND THE LIKE), EVEN IF ASUS HAS BEEN ADVISED OF THE POSSIBILITY OF SUCH DAMAGES ARISING FROM ANY DEFECT OR ERROR IN THIS MANUAL OR PRODUCT.

SPECIFICATIONS AND INFORMATION CONTAINED IN THIS MANUAL ARE FURNISHED FOR INFORMATIONAL USE ONLY, AND ARE SUBJECT TO CHANGE AT ANY TIME WITHOUT NOTICE, AND SHOULD NOT BE CONSTRUED AS A COMMITMENT BY ASUS. ASUS ASSUMES NO RESPONSIBILITY OR LIABILITY FOR ANY ERRORS OR INACCURACIES THAT MAY APPEAR IN THIS MANUAL, INCLUDING THE PRODUCTS AND SOFTWARE DESCRIBED IN IT.

Products and corporate names appearing in this manual may or may not be registered trademarks or copyrights of their respective companies, and are used only for identification or explanation and to the owners' benefit, without intent to infringe.

Contents

Contents	iii
Notices.....	iv
Safety information	vi
Care & Cleaning.....	ix
Takeback Services.....	x
Product information for EU energy label.....	x
Chapter 1: Product introduction	
1.1 Welcome!	1-1
1.2 Package contents.....	1-1
1.3 Monitor introduction.....	1-2
1.3.1 Front view	1-2
1.3.2 Back/Side view.....	1-4
1.3.3 Other Function(s)	1-5
1.3.4 Self Calibration.....	1-6
Chapter 2: Setup	
2.1 Using the short stand	2-1
2.2 Attaching the arm/base	2-2
2.3 Detaching the arm/base (for VESA wall mount).....	2-3
2.4 Installing the monitor hood.....	2-4
2.5 Using the cable clips	2-5
2.6 Adjusting the monitor.....	2-6
2.7 Connecting the cables.....	2-8
2.8 Turning on the monitor.....	2-9
Chapter 3: General instructions	
3.1 OSD (On-Screen Display) menu	3-1
3.1.1 How to reconfigure.....	3-1
3.1.2 OSD function introduction.....	3-2
3.2 Specifications summary.....	3-18
3.3 Outline dimensions.....	3-20
3.4 Troubleshooting (FAQ).....	3-24
3.5 Supported operating modes	3-25

Notices

Federal Communications Commission Statement

This device complies with Part 15 of the FCC Rules. Operation is subject to the following two conditions:

- This device may not cause harmful interference, and
- This device must accept any interference received including interference that may cause undesired operation.

This equipment has been tested and found to comply with the limits for a Class B digital device, pursuant to Part 15 of the FCC Rules. These limits are designed to provide reasonable protection against harmful interference in a residential installation. This equipment generates, uses and can radiate radio frequency energy and, if not installed and used in accordance with the instructions, may cause harmful interference to radio communications. However, there is no guarantee that interference will not occur in a particular installation. If this equipment does cause harmful interference to radio or television reception, which can be determined by turning the equipment off and on, the user is encouraged to try to correct the interference by one or more of the following measures:

- Reorient or relocate the receiving antenna.
- Increase the separation between the equipment and receiver.
- Connect the equipment into an outlet on a circuit different from that to which the receiver is connected.
- Consult the dealer or an experienced radio/TV technician for help.



The use of shielded cables for connection of the monitor to the graphics card is required to assure compliance with FCC regulations. Changes or modifications to this unit not expressly approved by the party responsible for compliance could void the user's authority to operate this equipment.

ENERGY STAR complied product



ENERGY STAR is a joint program of the U.S. Environmental Protection Agency and the U.S. Department of Energy helping us all save money and protect the environment through energy efficient products and practices.

All ASUS products with the ENERGY STAR logo comply with the ENERGY STAR standard, and the power management feature is enabled by default. The monitor and computer are automatically set to sleep after 10 and 30 minutes of user inactivity. To wake your computer, click the mouse or press any key on the keyboard. Please visit <http://www.energystar.gov/powermanagement> for detail information on power management and its benefits to the environment. In addition, please visit <http://www.energystar.gov> for detail information on the ENERGY STAR joint program.



NOTE: Energy Star is NOT supported on FreeDOS and Linux-based operating system.

Canadian Department of Communications Statement

This digital apparatus does not exceed the Class B limits for radio noise emissions from digital apparatus set out in the Radio Interference Regulations of the Canadian Department of Communications.

This class B digital apparatus complies with Canadian ICES-003.

This Class B digital apparatus meets all requirements of the Canadian Interference - Causing Equipment Regulations.

Cet appareil numérique de la classe B respecte toutes les exigences du Règlement sur le matériel brouiller du Canada.



For KMEPS

Under the unit's default settings, the system is required to remain in **low power mode**.

Consequently, parameters affecting power consumption, such as brightness, cannot be modified.

Safety information

- Before setting up the monitor, carefully read all the documentation that came with the package.
- To prevent fire or shock hazard, never expose the monitor to rain or moisture.
- Never try to open the monitor cabinet. The dangerous high voltages inside the monitor may result in serious physical injury.
- If the power supply is broken, do not try to fix it by yourself. Contact a qualified service technician or your retailer.
- Before using the product, make sure all cables are correctly connected and the power cables are not damaged. If you detect any damage, contact your dealer immediately.
- Slots and openings on the back or top of the cabinet are provided for ventilation. Do not block these slots. Never place this product near or over a radiator or heat source unless proper ventilation is provided.
- The monitor should be operated only from the type of power source indicated on the label. If you are not sure of the type of power supply to your home, consult your dealer or local power company.
- Use the appropriate power plug which complies with your local power standard.
- Do not overload power strips and extension cords. Overloading can result in fire or electric shock.
- Avoid dust, humidity, and temperature extremes. Do not place the monitor in any area where it may become wet. Place the monitor on a stable surface.
- Unplug the unit during a lightning storm or if it will not be used for a long period of time. This will protect the monitor from damage due to power surges.
- Never push objects or spill liquid of any kind into the slots on the monitor cabinet.
- To ensure satisfactory operation, use the monitor only with UL listed computers which have appropriate configured receptacles marked between 100-240V AC.
- If you encounter technical problems with the monitor, contact a qualified service technician or your retailer.
- Adjustment of the volume control as well as the equalizer to other settings than the center position may increase the ear-/headphones output voltage and therefore the sound pressure level.
- Ensure to connect the power cord to a socket-outlet with earthing connection.
- The supplied power adapter and/or power cable are designed to use with the product only. Do not use with other products.



The Waste Electrical and Electronic Equipment (WEEE) Directive (Directive 2012/19/EU) is a European Union law that aims to reduce the environmental impact of electrical and electronic equipment. It mandates producers to take responsibility for the end-of-life management of their products, promoting collection, treatment, and recycling to minimize waste and encourage resource recovery.

Do not throw your Electronic and electrical equipment in municipal waste.

The symbol of the crossed-out wheeled bin on the product or packaging indicates that this product (including any batteries it contains), must not be disposed of with your household waste.

To prevent potential harm to the environment and human health, a collection framework should be used to return, recycle, and recover waste electrical and electronic equipment (WEEE), and this product has been designed to enable the reuse of parts and facilitate the recycling of certain materials.

Improper disposal may involve risks due to the presence of hazardous substances within electrical and electronic equipment, such as lead and BFR and other harmful components.

Check your local recycling services for electronic products.

<https://esg.asus.com/en/circular-economy/resource-regeneration/global-take-back-service>

AEEE yönetmeliğine uygundur

Prevent Tipping

When using the display, fasten the monitor to a wall using a cord or chain that can support the weight of the monitor in order to prevent the monitor from falling.

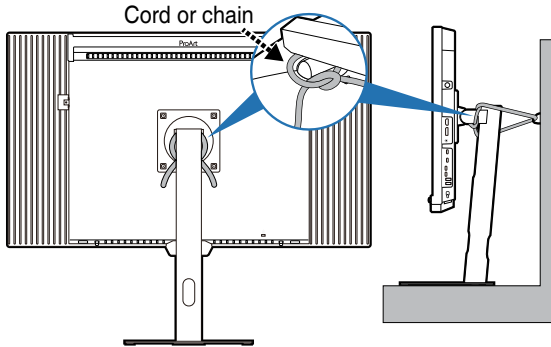
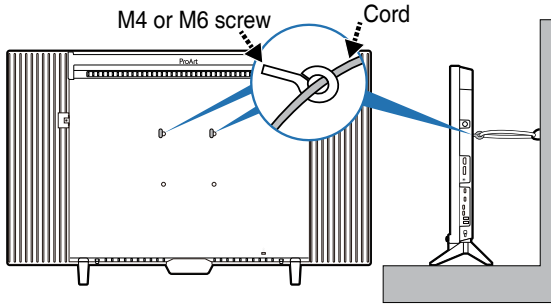

- Display design may differ from those illustrated.
- Installing must be done by a qualified technician, and please contact your supplier for more information.
- For the models with net weight ≥ 7 kg. Please select the suitable way to prevent tipping.
- Install the screws with ring to the VESA mount hole, then tie the cord or chain to the wall. Or, tie the cord or chain to the stand and then fix it to the wall.

Care & Cleaning

- Before you lift or reposition your monitor, it is better to disconnect the cables and power cord. Follow the correct lifting techniques when positioning the monitor. When lifting or carrying the monitor, grasp the edges of the monitor. Do not lift the display by the stand or the cord.
- Cleaning. Turn your monitor off and unplug the power cord. Clean the monitor surface with a lint-free, non-abrasive cloth. Stubborn stains may be removed with a cloth dampened with mild cleaner.
- Avoid using a cleaner containing alcohol or acetone. Use a cleaner intended for use with the monitor. Never spray cleaner directly on the screen, as it may drip inside the monitor and cause an electric shock.

The following symptoms are normal with the monitor:

- You may find slightly uneven brightness on the screen depending on the desktop pattern you use.
- When the same image is displayed for hours, an afterimage of the previous screen may remain after switching the image. The screen will recover slowly or you can turn off the Power Switch for hours.
- When the screen becomes black or flashes, or cannot work anymore, contact your dealer or service center to fix it. Do not repair the screen by yourself!

Conventions used in this guide



WARNING: Information to prevent injury to yourself when trying to complete a task.



CAUTION: Information to prevent damage to the components when trying to complete a task.



IMPORTANT: Information that you **MUST** follow to complete a task.



NOTE: Tips and additional information to aid in completing a task.

Where to find more information

Refer to the following sources for additional information and for product and software updates.

1. **ASUS websites**

The ASUS websites worldwide provide updated information on ASUS hardware and software products. Refer to <http://www.asus.com>

2. **Optional documentation**

Your product package may include optional documentation that may have been added by your dealer. These documents are not part of the standard package.

3. **About Flicker**

https://www.asus.com/Microsite/display/eye_care_technology/

Takeback Services

ASUS recycling and takeback programs come from our commitment to the highest standards for protecting our environment. We believe in providing solutions for our customers to be able to responsibly recycle our products, batteries and other components as well as the packaging materials.

Please go to <http://csr.asus.com/english/Takeback.htm> for detail recycling information in different region.

Product information for EU energy label



PA32USD

1.1 Welcome!

Thank you for purchasing the ASUS® OLED monitor!

The latest widescreen OLED monitor from ASUS provides a broader, brighter and crystal-clear display, plus a host of features that enhance your viewing experience.

With these features, you can enjoy the convenience and delightful visual experience that the monitor brings to you!

1.2 Package contents

Check your package for the following items:

- ✓ OLED monitor
- ✓ Monitor stand/base
- ✓ Short stand
- ✓ Quick start guide
- ✓ Warranty card
- ✓ Power cord
- ✓ Ultra High Speed HDMI cable
- ✓ DP UHBR80 cable (optional)
- ✓ USB Type-C to Type-A cable (optional)
- ✓ USB Type-C to Type-C cable (optional)
- ✓ Thunderbolt 4 passive 40G cable (optional)
- ✓ Monitor hood
- ✓ Cable clips
- ✓ Color calibration testing report



If any of the above items is damaged or missing, contact your retailer immediately.



If you need to replace the power cord or the connection cable(s), please contact ASUS customer service.

1.3 Monitor introduction

1.3.1 Front view

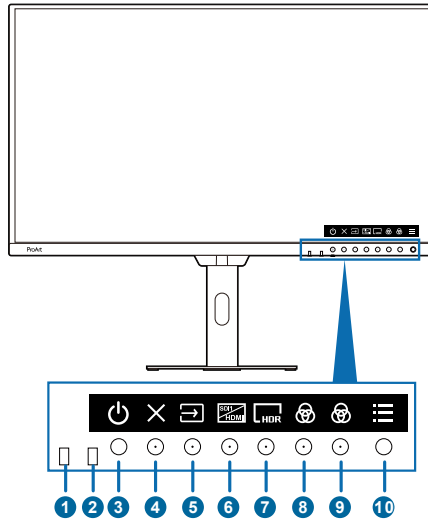

1. Proximity sensor

- When enabled, this feature will automatically reduce brightness periodically if the system does not detect an object within a distance of 30 cm to 90 cm for a preset duration.



- Recovery time is expected to be within 2 seconds.
- The detection ability and range may vary depending on the object and the environment.
- Avoid placing objects between 30 cm and 90 cm in front of the sensor, as this may cause the sensor to malfunction by misinterpreting the presence of an object ahead.
- This function will be disabled if the HDR function is enabled and the **Preset** setting is set to **HDR PQ_P3**, **HDR PQ_BT.2020**, **HDR HLG_BT.2020**, **HDR HLG_P3**, or **DolbyVision**.

2. Ambient light sensor

- Configures the ambient effect settings.





This function will be disabled if the HDR function is enabled and the **Preset** setting is set to **HDR PQ_P3**, **HDR PQ_BT.2020**, **HDR HLG_BT.2020**, **HDR HLG_P3**, or **DolbyVision**.

3. Power button/power indicator

- Turns the monitor on or off by pressing the button for over 0.6 seconds.
- The color definition of the power indicator is as the below table.

Status	Description
White	On
Amber	Standby mode
Off	Off

-  Exit button

 - Turns on the button functions menu when the OSD is off.
 - Exits the OSD menu.
-  Input Select button

 - Turns on the button functions menu when the OSD is off.
 - Selects an available input source.
-  SDI/HDMI button

 - Turns on the button functions menu when the OSD is off.
 - Default: HDMI
 - Switches between the SDI-1_12G and HDMI input sources.
-  HDR button

 - Turns on the button functions menu when the OSD is off.
 - Adjusts the HDR modes.
-  Shortcut 1 button

 - Turns on the button functions menu when the OSD is off.
 - Default: ProArt Preset: BT.709.
 - To change the hotkey function, go to the **Shortcut > Shortcut 1** menu.
-  Shortcut 2 button

 - Turns on the button functions menu when the OSD is off.
 - Default: ProArt Preset: P3.
 - To change the hotkey function, go to the **Shortcut > Shortcut 2** menu.
-  Menu button (5-way)

 - Turns on the button functions menu when the OSD is off.
 - Press this button to display the OSD menu.
 - Enacts the selected OSD menu item.
 - Increases/Decreases values or moves your selection up/down/left/right.
 - Push the button downwards for over 5 seconds to toggle the Key Lock function between on and off.

1.3.2 Back/Side view

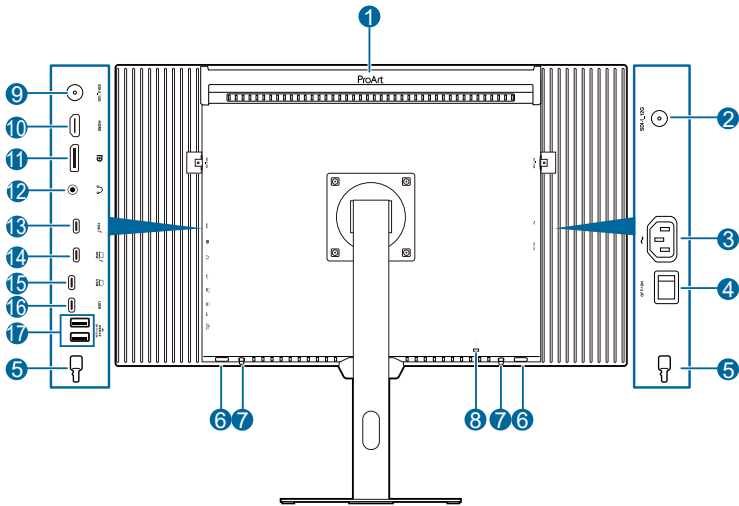

1. **Handle.**
2. **SDI-1_12G.** This port is for connection with SDI compatible device.





This connection is supported when Power Saving is set to Normal Level and HDMI is inactive.
3. **AC-IN port.** This port connects the power cord.
4. **Power switch.** Press the switch to turn on/off power.
5. **Cable clip slots.**
6. **Short stand slots.**
7. **Release button for short stand.**
8. **Kensington lock slot.**
9. **SDI-2_12G.** This port is for connection with SDI compatible device.
10. **HDMI port.** This port is for connection with an HDMI compatible device.

- 

When SDI-1_12G is off, default is on HDMI port.
11. **DisplayPort in.** This port is for connection with a DisplayPort compatible device.
12. **Earphone jack.**

13. **Thunderbolt out.** This port is for daisy chaining connection with a Thunderbolt compatible device or downstream connection with a USB Type-C device.
14. **Thunderbolt in.** This port is for connection with a Thunderbolt compatible device. This connection supports DisplayPort signal (Maximum resolution: 3840 x 2160@ 240Hz), USB power and data delivery.



The port with  icon offers 96W power delivery with output voltage/current of 5V/3A, 9V/3A, 15V/3A, 20V/3A (15 ~ 60W) & 20V/5A (60 ~ 96W). The port with  icon offers 15W power delivery with output voltage of 5V/3A.

15. **USB 3.2 Gen 2 Type-C (USB data only, upstream port).** This port is for connection with a USB Type-C compatible device which supports USB data delivery and PD 15W out.
16. **USB 3.2 Gen 2 Type-C (USB downstream port).** This port is for connection with USB devices, such as USB keyboard/mouse, USB flash drive, etc.
17. **USB 3.2 Gen 2 Type-A (USB downstream ports).** These ports are for connection with USB devices, such as USB keyboard/mouse, USB flash drive, etc.

1.3.3 Other Function(s)

- HDR

The monitor supports HDR format. When detecting HDR content, an "HDR ON" message will pop up and display in the Information page.

- Daisy chaining

The monitor supports daisy chain on Thunderbolt. Daisy Chaining allows up to multiple monitors to be connected in series with the video signal being passed from the source to a monitor. In order to enable daisy chaining, please make sure the source transported.

1.3.4 Self Calibration

The Self Calibration could be triggered by monitor OSD and ProArt Calibration Software.

Ensure the protective film on the color sensor has been removed before using the color sensor for calibration.

1. Execute ProArt Calibration Software to activate the embedded sensor to perform the color calibration.

Execute Calibration function from OSD menu to perform the color calibration.

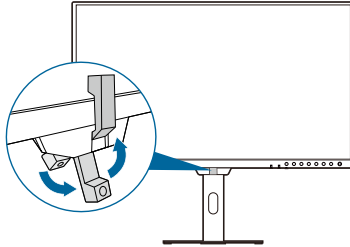

2. The color sensor starts moving from its original position towards the screen.

When the color sensor reaches the surface of the screen, it will start the calibration process.

The calibration time depends on the targeted items you selected, it might take 30 minutes if all of preset modes are selected.

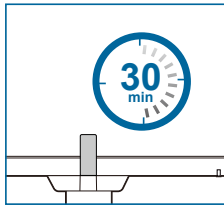

3. After the calibration process is completed, the color sensor will automatically return to its original position.



- When the device is turned on, the color sensor will return to its original position and produce a sound while the motor is running during the initialization process. This is normal.
- When the hood is installed, the color sensor can also be used.
- Avoid pulling the color sensor to prevent damage.
- To ensure ProArt Calibration Software to perform the calibration smoothly, do not touch the color sensor with your hands and there are no interfering objects during the process.

2.1 Using the short stand

To remove the short stand, follow these steps:

1. Press and hold the quick release button located on one side of the short stand.
2. Remove the short stand from that side.
3. Repeat steps 1 and 2 to remove the short stand from the other side.

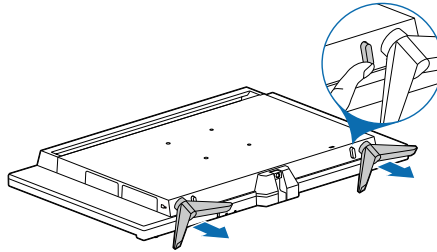

To assemble the short stand, insert it into the designated mounting holes at the bottom of the monitor.

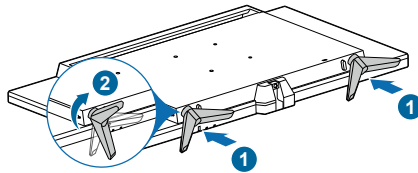

We recommend that you cover the table surface with soft cloth to prevent damage to the monitor.

2.2 Attaching the arm/base

To assemble the monitor arm/base:

1. Have the front of the monitor face down on a table.
2. Remove the rubbers in the four screw holes.
3. Secure the hinge plate to the monitor by tightening the bundled screw(s).
4. Insert the arm into the hinge plate until you hear a click, indicating that the arm is properly locked in place.
5. Attach the base to the arm by fastening the bundled screw(s).

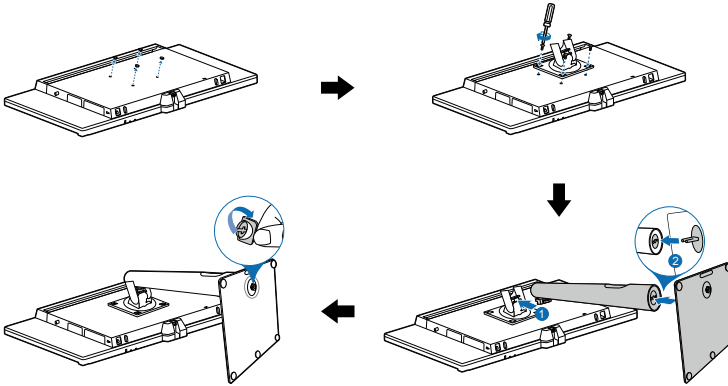

We recommend that you cover the table surface with soft cloth to prevent damage to the monitor.



Base screw size: M6 x 15 mm.

2.3 Detaching the arm/base (for VESA wall mount)

The detachable arm/base of this monitor is specially designed for VESA wall mount.

To detach the arm/base:

1. Have the front of the monitor face down on a table.
2. Use a screwdriver to remove the screw(s) on the hinge, then remove the stand.

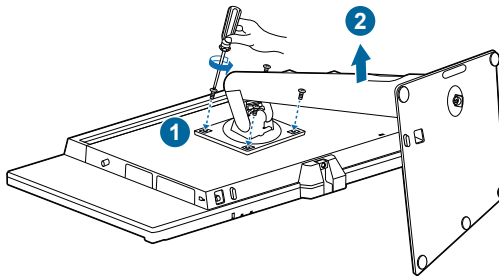

We recommend that you cover the table surface with soft cloth to prevent damage to the monitor.



- The VESA wall mount kit (100 x 100 mm) is purchased separately.
 - Use only the UL Listed Wall Mount Bracket with minimum weight/load 22.7kg (Screw size: M4 x 10 mm).
-

2.4 Installing the monitor hood

To install the hood:

1. Remove the tapes that holds it in place and open the hood.
2. Adjust the upper side of the hood to your desired length by extending or retracting it.
3. Attach the hood to the monitor as shown in the illustrations. Secure the hood to the monitor using the fixtures inside.
4. Wrap the rubber band around the back of the monitor to secure the hood in place.

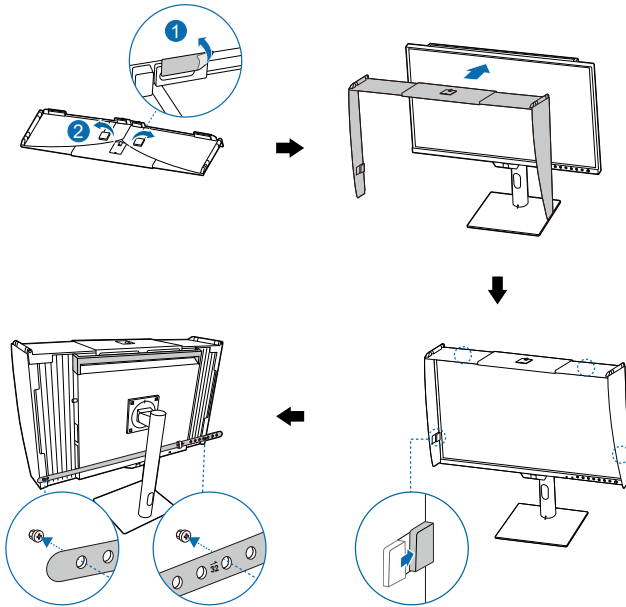

2.5 Using the cable clips

You can use cable clips to organize your connected cables. To install the cable clips:

1. Insert the clips as shown in the illustration.
2. Press down on the clips to secure them in place.

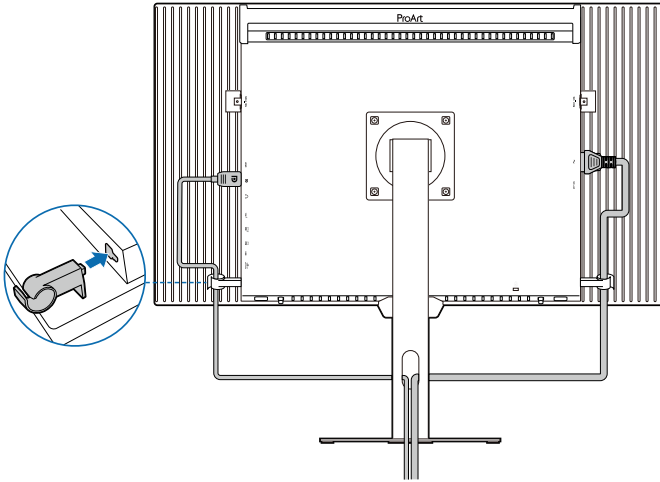

To remove the clips, simply push them back up and take them out.

2.6 Adjusting the monitor

- For optimal viewing, we recommend that you look at the full face of the monitor, then adjust the monitor to the angle that is most comfortable for you.
- Hold the stand to prevent the monitor from falling when you change its angle.
- You can adjust the monitor's angle from $+23^\circ$ to -5° , and it allows 30° swivel adjustment from either left or right. You can also adjust the monitor's height within 130 mm.

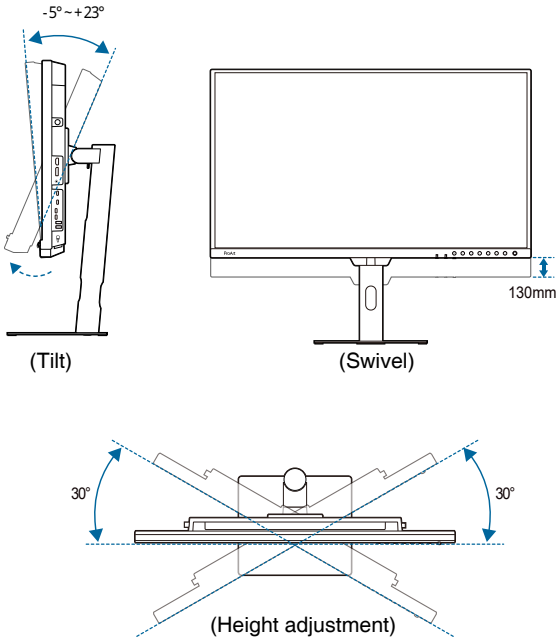

Pivoting the monitor

1. Lift the monitor to the highest position.
2. Tilt the monitor to its maximum angle.
3. Pivot the monitor to the angle you need.

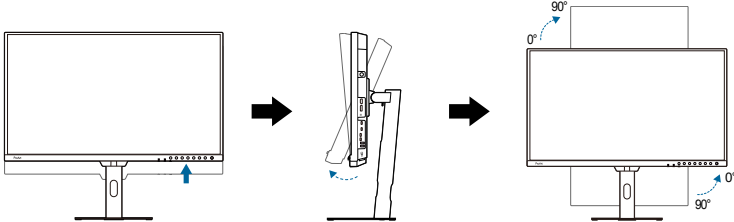

It is normal that the monitor slightly shakes while you adjust the viewing angle.

4. The OSD menu item will automatically rotate when the monitor rotates.

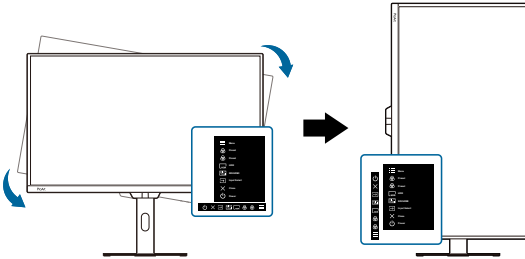

2.7 Connecting the cables

Connect the cables as the following instructions:

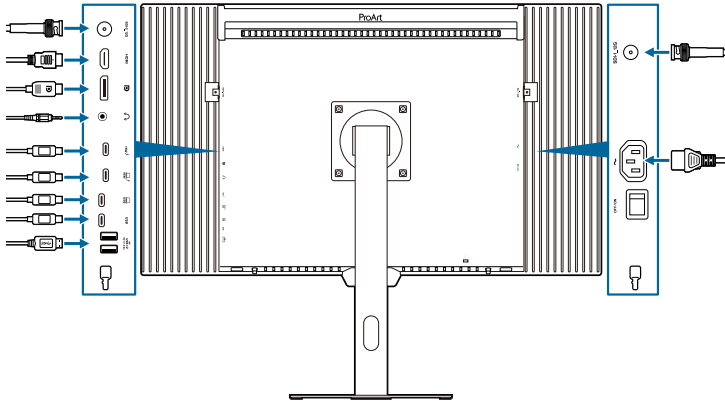

- **To connect the power cord:** Connect one end of the power cord securely to the monitor's AC input port, the other end to a power outlet.
- **To connect the HDMI/DisplayPort/Thunderbolt/SDI cable:**
 - a. Plug one end of the HDMI/DisplayPort/Thunderbolt/SDI cable to the monitor's HDMI/DisplayPort/Thunderbolt/SDI jack.
 - b. Connect the other end of the HDMI/DisplayPort/Thunderbolt/SDI cable to your device's HDMI/DisplayPort/Thunderbolt/SDI jack.
- **To use the earphone:** connect the audio cable to the monitor's earphone jack.
- **To use the USB 3.2 Gen 2 ports:**
 - » Upstream: Take an USB Type-C or USB Type-C to Type-A cable, and plug one end to the monitor's USB upstream port, and the other end to your computer's USB port. Make sure your computer is installed with the latest Windows 11 operating system. That will enable the USB ports on the monitor to work.
 - » Downstream: Plug the USB Type A/Type-C cable of your device to the monitor's USB Type A/Type-C jack.
 - » There are two scenarios for connecting devices:
 1. Using a Thunderbolt/USB Type-C cable for both video and USB data input: In this setup, the Thunderbolt/USB-C input serves as the upstream connection, while the Thunderbolt/USB-C output, USB Type-C, and USB Type-A ports are used for downstream connections.

- Using a DisplayPort for video input and Thunderbolt/USB Type-C for USB data input: Here, the Thunderbolt/USB-C input is upstream, and the Thunderbolt/USB-C output, USB Type-C, and USB Type-A ports function as downstream connections.





When these cables are connected, you can choose the desired signal from the **Input** item in the OSD menu.



If you need to replace the power cord or the connection cable(s), please contact ASUS customer service.





2.8 Turning on the monitor

Press the power button . See page 1-2 for the location of the power button. The power indicator  lights up in white to show that the monitor is ON.

3.1 OSD (On-Screen Display) menu

3.1.1 How to reconfigure



1. Press any button (except the Power button) to display the button functions menu.
 2. Press the  Menu (5-way) button to activate the OSD menu.
 3. Move the  Menu (5-way) button (left, right, up, or down) to toggle between options in the menu. As you move from one icon to another, the option name is highlighted.
 4. To select the highlighted item on the menu, press the  Menu (5-way) button.
 5. Move the  Menu (5-way) button to select the desired parameter or adjust the parameter value on the slide bar.
 6. To exit and save the OSD menu, move the 5-way button to the right repeatedly or press  until the OSD menu disappears. To adjust other functions, repeat steps 1-5.
- **ASUS DisplayWidget Center:** Displays a QR code for you to access the information about ASUS DisplayWidget Center.

3.1.2 OSD function introduction

1. Preset

Preset mode was calibrated in factory side to ensure the configuration of each mode could meet industry standard.



- **Native:** Present the original R,G,B color capability of panel.



Native meets Energy Star® requirements when **Power Saving** is **Deep Level**.



- **sRGB:** To calibrate display by following with sRGB color primary, D65 color temperature, Gamma 2.2 , best choice for document editing.
- **BT.709:** To calibrate display by following with BT.709 color primary, D65 color temperature, Gamma 2.4.
- **Adobe RGB:** To calibrate display by following with Adobe RGB color primary, D65 color temperature, Gamma 2.2.
- **P3:** To calibrate display by following with DCI-P3 color primary, D65 color temperature, Gamma 2.6.
- **BT.2020:** To calibrate display by following with BT.2020 color primary, D65 color temperature, Gamma 2.2.
- **DICOM:** Compatible with DICOM standard, best choice for medical image checking.
- **HDR PQ_P3:** High Dynamic Range. Contains three HDR modes (**PQ Optimized**, **PQ Clip**, and **PQ Basic**).
- **HDR PQ_BT.2020:** Compliant with BT.2020 color gamut and D65 white point.

- * **PQ Optimized:** Delivers the optimized HDR performance of this display with as much accuracy as with ST2084 in terms of display luminance capability.
- * **PQ Clip:** Preserves PQ curve till displaying maximum luminance with accuracy. ST2084 code value with higher than display maximum will be mapped to the maximum luminance.
- * **PQ Basic:** Presents HDR performance of general HDR supported displays.
- **HDR HLG_BT.2020:** Compliant with BT.2020.
- **HDR HLG_P3:** Compliant with P3.
- **DolbyVision:** Selects the DolbyVision lighting type.
 - * **Dark:** Compliant with DolbyVision Bright mode settings.
 - * **Bright:** Compliant with DolbyVision Dark mode settings.



Dolby, Dolby Vision, and the double-D symbol are registered trademarks of Dolby Laboratories Licensing Corporation. Manufactured under license from Dolby Laboratories Licensing Corporation. Confidential unpublished works. Copyright © 2013–2024 Dolby Laboratories. All rights reserved.

- **CAL1/CAL2/CAL3:** Allows you to customize preference via color calibration.



ASUS ProArt Calibration Software, Portrait Calman, and Light Illusion ColourSpace CMS all support color calibration applications.

Preset mode introduction:

sRGB	A standard RGB color space created for use on monitors, printers and the Internet	e-Publisher Web Design Graphic Design
BT.709	A color space standard of high-definition television (HDTV)	HD Video Producer
Adobe RGB	Designed to encompass most of the colors achievable on CMYK color printers	Photography Printing House Graphic Design for Printing
P3	A standard of content requirements, studios, digital cinema manufacturers can be assured of interoperability and compatibility	Digital Cinema Industry
BT.2020	A color space standard of Ultra high-definition television (UHDTV)	4K UHD Content Producer
DICOM	Compliant with DICOM standard, best choice for medical image checking	See every grayscale level to ensure accurate and precise pictures

HDR PQ_P3	Multiple HDR-10 curves with DCI-P3 color gamut and D65 white Point (PQ Clip, PQ Optimized, PQ Basic)	HDR-10 content producer for games and videos
HDR PQ_BT.2020	Multiple HDR-10 curves with BT.2020 color gamut and D65 white Point (PQ Clip, PQ Optimized, PQ Basic)	HDR-10 content producer for games and videos
HDR HLG_BT.2020	Compliant with BT2100	TV station for Broadcast and satellite TV
HDR HLG_P3	Compliant with DCI-P3	TV station for Broadcast and satellite TV
DolbyVision	Compliant with Dolby Vision standard and delivers dynamic metadata by frames, providing Bright/Dark mode for your needs	Movie and entertainment, it needs Dolby Vision format

Below table shows the default configurations for each Preset mode:

Function	Native	sRGB	BT.709	Adobe RGB	P3
Color Temp.	6500K	Fixed (6500K)	6500K	Fixed (6500K)	6500K
Target Brightness	210nits	80nits	100nits	160nits	48nits
Contrast	80	80	80	80	80
Sharpness	Enable	Enable	Enable	Enable	Enable
Saturation	Enable	Disable	Enable	Enable	Enable
Hue	Enable	Disable	Enable	Enable	Enable
Palette	Enable	Enable	Enable	Enable	Enable
Black Level	Enable	Enable	Enable	Enable	Enable
Input Range	Enable	Enable	Enable	Enable	Enable
EOTF (Gamma)	2.2	2.2	2.4	2.2	2.2/2.6 only
Light Sync - Brightness	Enable	Fixed (OFF)	Enable	Enable	Enable
Light Sync - Color Temperature	Enable	Fixed (OFF)	Enable	Fixed	Enable
Uniform Brightness	ON	ON	ON	ON	ON

Function	BT.2020	DICOM	HDR PQ_P3/ HDR PQ_BT.2020/ HDR HLG_BT.2020/ HDR HLG_P3	CAL1/ CAL2/ CAL3
Color Temp.	6500K	7500K	Fixed (6500K)	Fixed (6500K)
Target Brightness	100nits	200nits	250nits/400nits/Max.	Following Native mode setting
Contrast	80	80	Fixed	80
Sharpness	Enable	Enable	Enable	Enable
Saturation	Enable	Enable	Fixed	Enable
Hue	Enable	Enable	Fixed	Enable
Palette	Enable	Enable	Enable (RGB gain only)	Enable (RGB gain only)
Black Level	Enable	Enable	Enable	Enable
Input Range	Enable	Enable	Enable	Enable
EOTF (Gamma)	2.4	Fixed	Fixed	2.2
Light Sync - Brightness	Enable	Enable	Fixed (OFF)	Enable
Light Sync - Color Temperature	Enable	Enable	Fixed (OFF)	Enable
Uniform Brightness	ON	ON	OFF	OFF

2. Palette

Set a desired color setting from this menu.

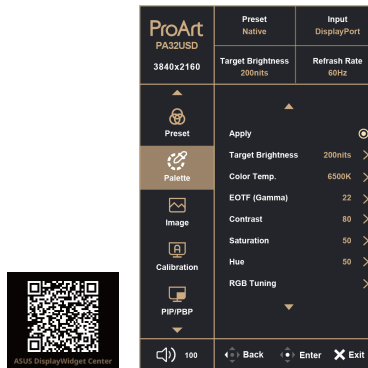

- **Apply:** Applies current **Palette** settings.
- **Target Brightness:** The adjusting range is from 0 to 400.
- **Color Temp.:** Contains 6 modes including **9300K, 7500K, 6500K, DCI (0.314,0.351), 5500K and 5000K.**

- **EOTF (Gamma):** Allows you to set the color mode to 2.6, 2.4, 2.2, 2.0, 1.8, PQ Optimized, PQ Clip or PQ Basic.
- **Contrast:** The adjusting range is from 0 to 100.
- **Saturation:** The adjusting range is from 0 to 100.
- **Hue:** Shifts the image color between green and purple.
- **RGB Tuning:**
 - * **Gain:** Adjusts the gain levels for R, G, B.
 - * **Offset:** Adjusts the black level offset values for R, G, B.
- **Black Level:** To adjust the initialized 1st signal level of darkest gray level.
 - * **Signal:** The adjusting range is from 0 to 240.
- **Reset: Yes** Allows you to restore items in the **Palette** menu to their default settings.

3. Image

Set the image related setting from this menu.



- **Sharpness:** The adjusting range is from 0 to 100.
- **Aspect Control:** Adjusts the aspect ratio to **Full**, **Dot to Dot**, or **1:1 Ratio**.



To activate this function, you need to do the following: turn off **Rapid Rendering** and **PIP/PBP**.

- **Input Range:** To map signal range with whole black to white presented range of display.
- **Blue Light Filter:** In this function, you can adjust the blue light filter from **0** to **Max**.



To activate this function, you need to do the following: set **Preset** to **Native**, turn off **Light Sync**, and disable HDR on your device.

- * **0:** No change.
- * **Max:** The higher the level, the less blue light is scattered. When blue light filter is activated, the default settings of **Native Mode** will be automatically imported. Besides maximum level, the brightness is user-configurable. Maximum is the optimized setting. The brightness function is not user configurable.



The monitor uses low blue light panel and compliance with TÜV Rheinland Low Blue Light Hardware Solution at factory reset/default setting mode.



Please refer to the following to alleviate eye strains:

- Users should take some time away from the display if working for long hours. It is advised to take short breaks (at least 5 mins) after around 1 hour of continuous working at the computer. Taking short and frequent breaks is more effective than a single longer break.
 - To minimize eye strain and dryness in your eyes, users should rest the eye periodically by focusing on objects that are far away.
 - Eye exercises can help to reduce eye strain. Repeat these exercises often. If eye strain continues please consult a physician. Eye exercises: (1) Repeating look up and down (2) Slowly roll your eyes (3) Move your eyes diagonally.
 - High energy blue light may lead to eye strain and AMD (Age-Related Macular Degeneration). Blue light filter to reduce 70% (max.) of harmful blue light to avoid CVS (Computer Vision Syndrome) when the user adjusts blue light filter bar to maximum level.
-

4. Calibration

This function carries out standalone calibration to guarantee color accuracy for each working period.



To keep the schedule accurate, ensure that the AC switch is always in the ON position.

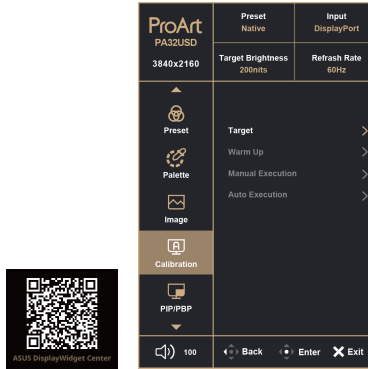

- **Target:** Selects the preset modes to perform standalone calibration. Single or multiple modes are both workable.
- **Warm Up(30 minutes):** Sets whether to warm up for 30 minutes before standalone calibration. (Recommended)
- **Manual Execution:** Manually performs the standalone calibration. Select **Yes** to start.
- **Auto Execution:** Allows the system to automatically perform standalone calibration for your personalized time setup.
 - * **Clock:** Sets the current time.



Set the current time if this is your first time usage of the **Auto Execution** function.

- * **Appointment:** Sets the start time of standalone calibration.



The setting of **Appointment** should be scheduled for a time later than the **Clock** time.

- * **Routine:** Sets the repeat cycle of standalone calibration.



Auto Execution will be disabled when **OFF** is selected.

5. PIP/PBP

The PIP/PBP menu allows you to open up another sub-window connected from another video source (when input source is below 60Hz) besides the main-window from your original video source.



To activate this function, you need to do the following: turn off **Rapid Rendering** and disable HDR on your device.

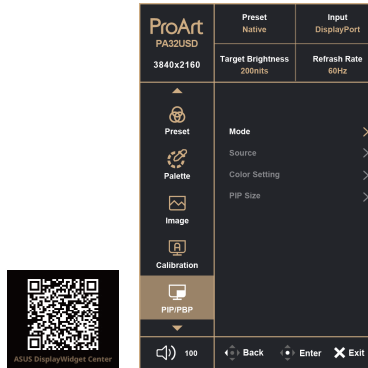

- **Mode:** Selects **PIP**, **PBP** function, or turn it off.



To scale both displays to full screen in PBP mode, set resolution settings for both as 1920 x 2160 in OS display settings. (And make sure that the scaling option is "Maintain Display Scaling" if you are using an Intel graphics card.)

- **Source:** Selects the video input source from among **HDMI/SDI-1**, **SDI-2**, **DisplayPort** and **Thunderbolt**.
- **Color Setting:** Selects an individual Preset Mode for the selected PIP/PBP source.
- **PIP Size:** Adjusts the PIP size to **Small**, **Medium**, or **Large**. (Only available for the PIP mode)

6. QuickFit Plus

In this function, you can use different kinds of alignment patterns.





To activate this function, you need to do the following: turn off PIP/PBP on your device and restore your screen back to normal position (do not rotate).





- Safe Area:** Facilitates designers and users to organize content and layout on one page and achieve a consistent look and feel. The selections are: **1 : 1**, **Action Safe**, **Title Safe**, **3 x 3**.

1 : 1	Action Safe
Title Safe	3 x 3

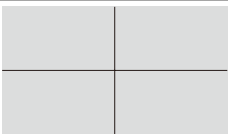
- **Center Marker:** Adjusts the **Type 1, Type 2, Type 3.**

Type 1	Type 2
	
Type 3	
	

- **Customization:** You can decide the frame size by moving the  Menu (5-way) button up/down/left/right. You can press the  Menu (5-way) button for longer than 3 seconds to switch the measurements between millimeter and inch.



- **Ruler:** This pattern presents physical ruler on top and left side. You can press the  Menu button for longer than 3 seconds to switch the measurements between metric and imperial.



- **Mirror Mode:** Flips the image horizontally.

7. Input

In this function, you can select your desired input source or decide if you want the monitor to automatically searches for input sources.

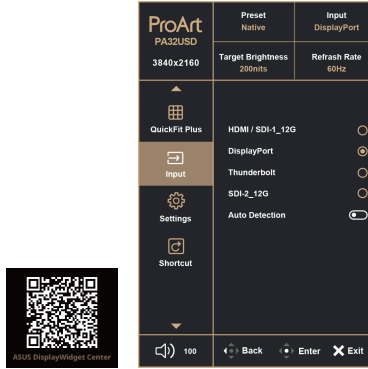

- **HDMI/SDI-1, DisplayPort, Thunderbolt, SDI-2:** Manually selects the input source.
- **Auto Detection:** Automatically detects other active signals when current input signal is inactive.



To activate this function, you need to do the following: Set **Power Saving** in the **Settings** menu to **Normal Level**.



When **Deep Level** is selected in the **Power Saving** menu, you must manually choose the input source after the monitor enters standby mode if you want to use any input source. In contrast, when **Normal Level** is selected in the **Power Saving** menu, the only input source that requires manual selection after entering standby mode is the **SDI-1** input source, should you wish to use it.

8. Settings

Allows you to adjust the system.



- **HDR Preview:** Allows you to preview non-HDR content performance with HDR10 and HLG mapping. While **HDR Preview** function is on, **HDR PQ_P3**, **HDR PQ_BT.2020**, **HDR HLG_BT.2020** and **HDR HLG_P3** can be chosen.
- **DolbyVision:** Enables or disables the DolbyVision function.
- **Rapid Rendering:**
 - * **Upto 120Hz:** 48~120Hz.
 - * **Upto 240Hz:** 48~96Hz double frame rate/ 96~240Hz pass through.
 - * **Native:** 48~240Hz.
 - * **OFF:** VRR Off.



To activate this function, you need to do the following: turn off **PIP/PBP**, set **Aspect Control** to **Full**.

- **Uniform Brightness:** When this feature is enabled, the system will maintain the maximum screen brightness, regardless of the displayed screen size. If enabled, the maximum brightness is approximately 250 nits. By default, **Uniform Brightness** is set to **On** in SDR modes and **Off** in HDR modes.
- **Power Saving:**
 - * **Normal Level:** Allows the USB downstream ports/USB Type-C ports to charge external devices when the monitor enters power saving mode.

- * **Deep Level:** When connected to a computer, the upstream port enables the USB downstream ports to charge devices. **Auto Detection** will be disabled.



When **Deep Level** is selected, **Brightness** will be fixed at 80. Additionally, the following function(s) will be disabled: **SDI**, **OSD Auto Rotation**, and audio function.

- **OSD Setup:**

- * **OSD Timeout:** Adjusts the OSD timeout from 10 to 120 seconds.
- * **DDC/CI:** Enables or disables the DDC/CI function.
- * **Transparency:** Adjusts the OSD background from opaque to transparent.
- * **OSD Auto Rotation:** Adjusts the OSD rotation.



To activate this function, you need to do the following: turn off **PIP/PBP**, set **Power Saving to Normal Level**.

- **Language:** There are 23 languages for your selection, including English, French, German, Italian, Spanish, Dutch, Portuguese, Russian, Czech, Croatian, Polish, Romanian, Hungarian, Turkish, Simplified Chinese, Traditional Chinese, Japanese, Korean, Thai, Indonesian, Persian, Ukrainian, Vietnamese.
- **Sound:**
 - * **Volume:** The adjusting range is from 0 to 100.
 - * **Mute:** Toggles the monitor audio output between on and off.
 - * **Source:** Selects audio input from PIP/PBP sources.



To activate **Sound** function, you need to do the following: set **Power Saving to Normal Level**.

To activate **Source** function, you need to do the following: turn on **PIP/PBP**.

- **DisplayPort Stream:** Compatibility with graphics card. Select **DP1.2**, **DP1.4** or **DP2.1+USB3.2** by graphics card DP version.
- **Lock:**
 - * **Key:** To disable all function keys. Push the  Menu button downwards for over 5 seconds to cancel the key lock function.
 - * **Preset Setting:** To lock all parameters and disable (gray out) ProArt Palette.
- **Power Indicator:** Turns the power LED indicator on/off.
- **Light Sync:** Adjusts luminance and color temperature according to ambient condition.
 - * **Brightness:** Adjusts luminance dynamically according to ambient lighting.

- * **Color Temperature:** Adjusts color temperature dynamically according to ambient lighting.



To activate **Brightness** function, you need to do the following: turn off **Screen Saver**.

To activate **Color Temperature** function, you need to do the following: set **Blue Light Filter** to 0.

- **Screen Saver:**

- * **Proximity Sensor:** When enabled, this feature will automatically reduce brightness periodically if the system does not detect an object within a distance of 30 cm to 90 cm for a preset duration.



- Recovery time is expected to be within 2 seconds.
 - The detection ability and range may vary depending on the object and the environment.
 - Avoid placing objects between 30 cm and 90 cm in front of the sensor, as this may cause the sensor to malfunction by misinterpreting the presence of an object ahead.
-

- * **Panel Protection:** This feature incorporates various mechanisms from the panel's intelligent patents to extend its lifespan. These mechanisms include **Sensing Protection**, **Pixel Shift**, **Screen Saver**, **ISP**, and **Off Sensing**. You can adjust the slider to configure different levels, and some standard behaviors listed below will occur:

1. The screen brightness will automatically decrease when there is no change on the screen.
 2. When the accumulated time is reached (default: 12 hours), **Off Sensing** will automatically activate when the monitor enters standby or off mode. If the monitor is powered on or if any button is pressed during the process, **Off Sensing** will stop functioning and will resume when the monitor enters standby or off mode again.
-



The cumulative time settings for **Off Sensing** are as follows:

OFF: 24 hours
Level 1: 12 hours
Level 2: 6 hours

Below table shows the **Panel Protection** configuration table:

Parameter Setting	OSD bar		
	OFF	Level 1	Level 2
Sensing Protection	OFF	ON	ON
Pixel Shift	OFF	Slow	Normal
Screen Saver			
- Luminance	OFF	Level 3	Level 6
- Waiting Time	OFF	Slow	Fast
- Activation Speed	OFF	Slow	Fast
ISP (Global)			
- Luminance	OFF	Level 3	Level 6
- Waiting Time	OFF	Slow	Fast
- Activation Speed	OFF	Slow	Fast
- Recovery Speed	OFF	Slow	Fast
Off Sensing	Sensing Compensation per 24 hours	Sensing Compensation per 12 hours	Sensing Compensation per 6 hours

- * **Image Protection:** This feature integrates several mechanisms from the panel's intelligent patents to safeguard its lifespan. It can prevent potential picture quality issues when images contain multiple logos (**Multi-Logo**), exhibit edge luminance averaging (**Edge Lum Average**) or contain **Task Bar**. You can adjust the slider to configure different levels for this feature as well.
- **KVM:** This feature allows users to assign the appropriate USB upstream ports to their HDMI or DisplayPort connections based on the following rules:
 - * **Upstream-1/Auto-Thunderbolt Priority:** After an **All Reset**, the system defaults to **Upstream-1/Auto-Thunderbolt** if it is connected.
 - * **First Connected Priority:** The first connected upstream port takes precedence. This means that if only one upstream is connected, the KVM will switch to it automatically, regardless of the settings in the OSD menu.
 - * **Last Effective Option:** Upon powering on, the KVM will select the last active option if both upstreams are connected.
 - * **Manual and Automatic Switching:** The KVM will switch to the appropriate port after a manual port switch or automatically if there is a matching option selected.

- * Immediate Switching on OSD Change: If any option in the OSD menu is changed, the KVM will switch immediately, but only if the corresponding upstream is connected.
- **HDMI CEC:** Enables or disables the HDMI CEC function. To activate this function, you can use the remote control to connect the device to the monitor via an HDMI port.
- **Information:** Shows the monitor information.
- **All Reset: Yes** Allows you to restore the default settings.
- **ProArt Support:** Scan the QR code for ASUS support: https://www.asus.com/support/?utm_source=%20asus-product&utm_medium=%20referral&utm_campaign=manual

9. Shortcut

Defines the functions for Shortcut 1 and 2 buttons.

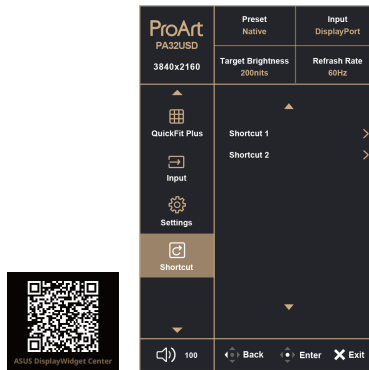

- **Shortcut 1/Shortcut 2:** Selects a function for Shortcut 1 and 2 buttons.



When a certain function is selected or activated, your shortcut key may not support. Available function choices for shortcut: **Blue Light Filter, Target Brightness, Preset, EOTF (Gamma), Color Temp., PIP/PBP, CAL1, CAL2, CAL3.**

3.2 Specifications summary

Panel Type	OLED
Panel size	31.5" (16:9) wide screen
Max. Resolution	3840 x 2160
Pixel pitch	0.1814 mm x 0.1814 mm
Brightness	SDR 300 nits (Typ.), HDR 1000 nits (APL 3%)
Contrast Ratio (Typ.)	1,500,000:1
Viewing angle (H/V) CR>10	178°/178°
Display colors	1.07B (10 bit)
Response time	0.1 ms (Typ., GTG)
ProArt Preset selection	15 color preset modes
Color temperature selection	6 color temperatures
Analog input	No
Digital input	1 x HDMI 2.1, 1 x DP2.1, 1 x Thunderbolt 4, 2 x 12G-SDI
Digital Output	1 x Thunderbolt 4
Earphone jack	Yes
Audio input	No
Speaker (Built-in)	3 W x 2 (4ohm)
USB 3.2 port	USB 3.2 Gen 2 Type-C x 1 (upstream, data only), USB 3.2 Gen 2 Type-C x 1, USB 3.2 Gen 2 Type-A x 2
Colors	Black
Power LED	White (On)/Amber (Standby)
Tilt	+23° ~ -5° (with stand)
Pivot	+90° ~ -90° (with stand)
Swivel	+30° ~ -30° (with stand)
Height Adjustment	130 mm (with stand)
Kensington lock	Yes
DC input voltage	AC: 100~240V, 5.0 A
Power consumption	Power On: < 50 W** (Typ.), Standby: < 0.5 W (Typ.), DC Power Off: < 0.3 W / Hard switch: 0 W
Temperature (Operating)	0°C~40°C
Temperature (Non-operating)	-20°C~+60°C
Dimension (W x H x D) without stand	718.28 x 440.12 x 59.59 mm
Dimension (W x H x D)	718.28 x 482.92 x 162.83 mm (with short stand); 718.28 x 615.82 x 239.72 mm (with stand, highest); 718.28 x 485.82 x 239.72 mm (with stand, lowest) 900 x 685 x 225 mm (package)
Weight (Esti.)	6.54 kg (monitor only); 6.96 kg (with short stand); 9.08 kg (with stand); 9.50 kg (Net, with stand and short stand); 17.03 kg (Gross)

Multi-languages	23 languages (English, French, German, Italian, Spanish, Dutch, Portuguese, Russian, Czech, Croatian, Polish, Romanian, Hungarian, Turkish, Simplified Chinese, Traditional Chinese, Japanese, Korean, Thai, Indonesian, Persian, Ukrainian, Vietnamese)
Accessories	Short stand, quick start guide, warranty card, power cord, Ultra High Speed HDMI cable, DP UHBR80 cable (optional), USB Type-C to Type-A cable (optional), USB Type-C to Type-C cable (optional), Thunderbolt 4 passive 40G cable (optional), monitor hood, cable clips, color calibration testing report
Compliance and Standards	cTUVus, FCC, ICES-3, EPEAT, CB, CE, ErP, WEEE, EU Energy, ISO 9241-307, UkrSEPRO, CU, EAC RoHs, CCC, CEL, BSMI, RCM, MEPS, VCCI, PSE, PC Recycle, J-MOSS, KC, KCC, KMEPS, PSB, Vietnam Energy, Ukraine Energy, Energy Star [®] , RoHs, CEC, SIOC, Windows 11 WHQL, TÜV Flicker Free, TÜV Low Blue Light, VESA DisplayHDR True Black 400, Mac Compliance, Thunderbolt4 Certification, Dolby Vision, HDMI CEC, China RoHs

*Specifications are subject to change without notice.

**Measuring a screen brightness of 200 nits without audio/USB/Card reader connection.

3.3 Outline dimensions

ASUS PA32USD Outline Dimension
 *Unit:mm(Inch)

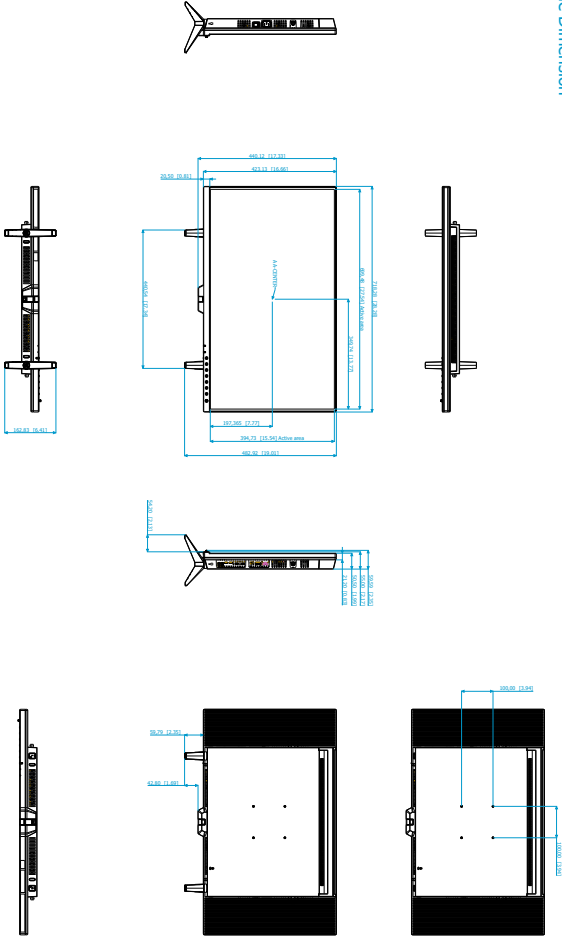

Monitor hood (folded)

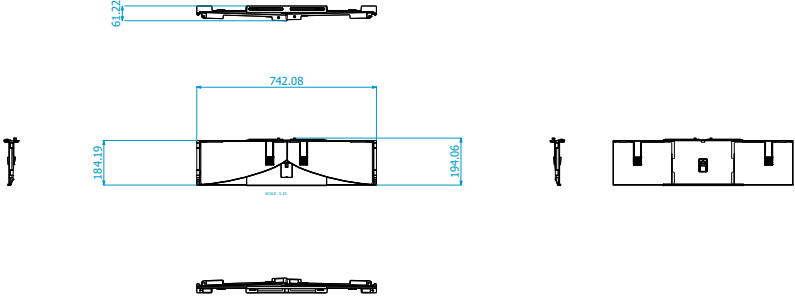

Monitor hood (fully opened)

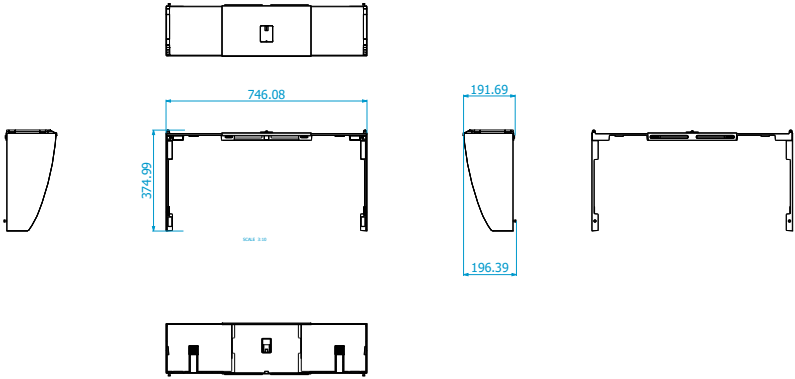

Monitor hood (for 32" monitor)

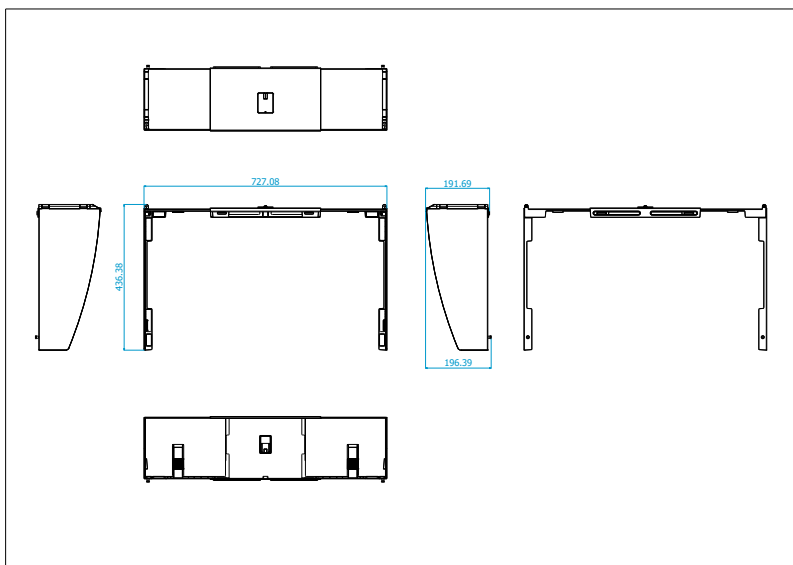

Monitor hood with rubber belt (for 32" monitor)

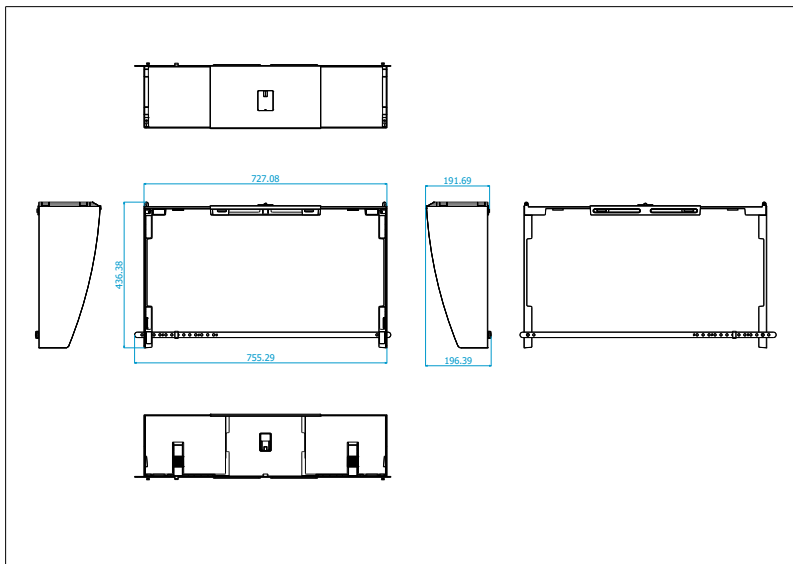

3.4 Troubleshooting (FAQ)

Problem	Possible Solution
Power LED is not ON	<ul style="list-style-type: none">• Press the  button to check if the monitor is in the ON mode.• Check if the power cord is properly connected to the monitor and the power outlet.• Check if the power switch is ON.
The power LED lights amber and there is no screen image	<ul style="list-style-type: none">• Check if the monitor and the computer are in the ON mode.• Make sure the signal cable is properly connected the monitor and the computer.• Inspect the signal cable and make sure none of the pins are bent.• Connect the computer with another available monitor to check if the computer is properly working.
Screen image is too light or dark	<ul style="list-style-type: none">• Adjust the Contrast and Brightness settings via OSD.
Screen image bounces or a wave pattern is present in the image	<ul style="list-style-type: none">• Make sure the signal cable is properly connected to the monitor and the computer.• Move electrical devices that may cause electrical interference.
Screen image has color defects (white does not look white)	<ul style="list-style-type: none">• Inspect the signal cable and make sure that none of the pins are bent.• Perform All Reset via OSD.• Adjust the R/G/B color settings or select the Color Temperature via OSD.
No sound or sound is low	<ul style="list-style-type: none">• Ensure that the HDMI/DisplayPort/Thunderbolt cable is properly connected to the monitor and the computer.• Adjust the volume settings of both your monitor and HDMI/DisplayPort/Thunderbolt device.• Ensure that the computer sound card driver is properly installed and activated.

3.5 Supported operating modes

Resolution	Frequency	Vertical Frequency (Hz)
640 x 480		60Hz
640 x 480		75Hz
800 x 600		60Hz
800 x 600		75Hz
1024 x 768		60Hz
1024 x 768		75Hz
1280 x 1024		60Hz
1280 x 720		60Hz
1280 x 960		60Hz
1600 x 1200		60Hz
1920 x 1080		60Hz
1920 x 2160		60Hz
1920 x 2160		240Hz
2560 x 1440		60Hz
2560 x 1440		120Hz
2048 x 1536		60Hz
2560 x 2048		60Hz
3280 x 2048		60Hz
3840 x 2160		23.976Hz
3840 x 2160		29.97Hz
3840 x 2160		59.95Hz
3840 x 2160		60Hz
3840 x 2160		240Hz

When the monitor is operating in the video mode (ie, not displaying data), the following high definition modes shall be supported in addition to standard definition video.

Resolution Frequency	Vertical Frequency (Hz)
640 x 480P	59.94/60Hz
720 x 480P	59.94/60Hz
720 x 480P	59.94/60Hz
1280 x 720P	59.94/60Hz
1920 x 1080i	60Hz
720(1440) x 480i	60Hz
1920 x 1080p	60Hz
720 x 576p	50Hz
720 x 576p	50Hz
1280 x 720P	50Hz
1920 x 1080i	50Hz
720(1440) x 576i	50Hz
1920 x 1080p	50Hz
1920 x 1080p	24Hz
1920 x 1080p	25Hz
1920 x 1080p	30Hz
1920 x 1080p	100Hz
1920 x 1080p	120Hz
3840 x 2160p	24Hz
3840 x 2160p	25Hz
3840 x 2160p	30Hz
3840 x 2160p	50Hz
3840 x 2160p	60Hz
3840 x 2160p	100Hz
3840 x 2160p	120Hz

Single-Link 12Gb/s SDI Support Video Format

Data Rate	SDI Serial Interface	Pixels	Line	Frame Rate (Hz)	Source Image Format
12G	Single 12Gb/s	4096	2160p	50,59.94,60	10-bit 4:2:2(Y'C'bC'r)
		4096	2160p	24,25,29.97,30	10-bit 4:4:4(Y'C'bC'r) 10-bit 4:4:4(R'G'B') 12-bit 4:2:2(Y'C'bC'r) 12-bit 4:4:4(Y'C'bC'r) 12-bit 4:4:4(R'G'B')
		3840	2160p	50,59.94,60	10-bit 4:2:0(Y'C'bC'r) 10-bit 4:2:2(Y'C'bC'r)
		3840	2160p	24,25,29.97,30	10-bit 4:4:4(Y'C'bC'r) 10-bit 4:4:4(R'G'B') 12-bit 4:2:2(Y'C'bC'r) 12-bit 4:4:4(Y'C'bC'r) 12-bit 4:4:4(R'G'B')
6G	Single 6Gb/s	4096	2160p	24,25,29.97,30	10-bit 4:2:2(Y'C'bC'r)
		3840	2160p	24,25,29.97,30	10-bit 4:2:0(Y'C'bC'r) 10-bit 4:2:2(Y'C'bC'r)
		2048	1080p	50,59.94,60	10-bit 4:4:4(Y'C'bC'r) 10-bit 4:4:4(R'G'B') 12-bit 4:2:2(Y'C'bC'r) 12-bit 4:4:4(Y'C'bC'r) 12-bit 4:4:4(R'G'B')
		1920	1080p	50,59.94,60	10-bit 4:4:4(Y'C'bC'r) 10-bit 4:4:4(R'G'B') 12-bit 4:2:2(Y'C'bC'r) 12-bit 4:4:4(Y'C'bC'r) 12-bit 4:4:4(R'G'B')
3G	Single 3Gb/s	2048	1080p	50,59.94,60	10bit 4:2:2
		2048	1080p	24,25,29.97,30	10-bit 4:4:4(Y'C'bC'r) 10-bit 4:4:4(R'G'B') 12-bit 4:2:2(Y'C'bC'r) 12-bit 4:4:4(Y'C'bC'r) 12-bit 4:4:4(R'G'B')
		1920	1080p	50,59.94,60	10bit 4:2:2(Y'C'bC'r)
		1920	1080p	24,25,29.97,30	10-bit 4:4:4(Y'C'bC'r) 10-bit 4:4:4(R'G'B') 12-bit 4:2:2(Y'C'bC'r) 12-bit 4:4:4(Y'C'bC'r) 12-bit 4:4:4(R'G'B')
		1280	720p	25,29.97,30 0,50,59.94,60	10-bit 4:4:4(Y'C'bC'r) 10-bit 4:4:4(R'G'B')
HD	Single HD	2048	1080p	24,25,29.97,30	10-bit 4:2:2(Y'C'bC'r)
		1920	1080p	24,25,29.97,30	10-bit 4:2:2(Y'C'bC'r)
		1920	1080i	50,59.94,60	10-bit 4:2:2(Y'C'bC'r)
		1280	720p	25,29.97,30, 50,59.94,60	10-bit 4:2:2(Y'C'bC'r)

Trademark information

Dolby, Dolby Vision, and the double-D symbol are registered trademarks of Dolby Laboratories Licensing Corporation. Manufactured under license from Dolby Laboratories Licensing Corporation. Confidential unpublished works. Copyright © 2013–2024 Dolby Laboratories. All rights reserved.

ASUS