

Alienware 25 300Hz Gaming Monitor

AW2526HL

Alienware 27 280Hz Gaming Monitor

AW2726DL

User's Guide

Notes, cautions, and warnings

- ① **NOTE:** A NOTE indicates important information that helps you make better use of your product.
- △ **CAUTION:** A CAUTION indicates either potential damage to hardware or loss of data and tells you how to avoid the problem.
- ⚠ **WARNING:** A WARNING indicates a potential for property damage, personal injury, or death.

Contents

Safety instructions	5
About your monitor	6
Package contents	6
Product features	7
Operating system compatibility	10
Identifying parts and controls	11
Front view	11
Back view	12
Side view	12
Bottom view	13
Monitor specifications	15
Resolution specifications	16
Supported video modes	16
Preset display modes	17
Electrical specifications	21
Physical characteristics	22
Environmental characteristics	23
Pin assignments	24
DisplayPort	24
HDMI 1/HDMI 2 port	25
Plug-and-Play	26
LCD monitor quality and pixel policy	26
Ergonomics	27
Handling and moving your display	28
Maintenance guidelines	29
Cleaning your monitor	29
Setting up the monitor	30
Connecting the stand	30
Using the tilt, swivel, pivot and height adjustment	32
Tilt and swivel adjustment	32
Height adjustment	32
Pivot adjustment	32
Adjusting the rotation display settings of your system	33
Organizing your cables	34
Connecting your monitor	35
Connecting the DisplayPort cable	35
Connecting the HDMI cable (optional)	35
Securing your monitor using Kensington lock (optional)	36
Removing the monitor stand	37
VESA wall mounting (optional)	37
Operating the monitor	38
Turn on the monitor	38
Using the joystick control	38
Accessing the Menu Launcher	39
Using the On-Screen Display (OSD) menu	40

Accessing the menu system	40
OSD warning message	48
Locking the control buttons	51
Setting the maximum resolution	52
Troubleshooting	53
Self-test	53
Built-in diagnostics	54
Common problems	55
Regulatory information	58
FCC notices (U.S. Only) and other regulatory information	58
EU product database for energy label and product information sheet	58
Contacting Dell	59
Revision History	60

Safety instructions

Use the following safety guidelines to protect your monitor from potential damage and to ensure your personal safety. Unless otherwise noted, each procedure which is in this document assumes that you have read the safety information that is shipped with your monitor.

- ① **NOTE:** Before using the monitor, read the safety information that is shipped with your monitor and is printed on the product. Keep the documentation at a secure location for future reference.
- ⚠ **WARNING: Use of controls, adjustments, or procedures other than those procedures specified in this documentation may result in exposure to shock, electrical hazards or mechanical hazards, or both.**
- ⚠ **CAUTION: The possible long-term effect of listening to audio at high volume through the headphones (on monitors that support it) may damage your hearing ability.**
- Place the monitor on a solid surface and handle it carefully.
 - If the monitor is dropped or struck by a sharp object, the screen can be damaged because it is fragile.
 - Ensure that your monitor is electrically rated to operate with the AC power available in your location.
 - Keep the monitor in room temperature. Excessive cold or hot conditions can have an adverse effect on the liquid crystal of the display.
 - Connect the power cable from the monitor to a wall outlet that is near and accessible. See [Connecting your monitor](#).
- Do not place and use the monitor on a wet surface or near water.
- Do not subject the monitor to severe vibration or high impact conditions. For example, do not place the monitor inside a car trunk.
- Unplug the monitor when it is going to be left unused for an extended period.
- To avoid electric shock, do not attempt to remove any cover or touch the inside of the monitor.
- Read these instructions carefully. Keep this document for future reference. Follow all warnings and instructions that are marked on the product.
- Certain monitors can be wall mounted using the VESA mount that is purchased separately. Ensure to use the correct VESA specifications as mentioned in the wall-mounting section of the User's Guide.

For information about safety instructions, see the Safety, Environmental, and Regulatory Information (SERI) document that is shipped with your monitor.








About your monitor

Package contents

The following table provides the list of components that are shipped with your monitor. If any component is missing, contact Dell. For more information, see [Contacting Dell](#).

- ① **NOTE:** Some components may be optional and may not ship with your monitor. Some features may not be available in certain countries.
- ① **NOTE:** Dell monitors are designed to work optimally with the video cables that are shipped with your monitor. Dell cannot guarantee the video performance of cables that are not included with your Dell monitor, as it has no control over suppliers, materials, connectors, and manufacturing processes.

Table 1. Monitor components and descriptions.

Component image	Component description
	Display
	Stand riser
	Stand base
	<ul style="list-style-type: none">▪ Allen key▪ 4x screws (M4x10)
	DisplayPort to DisplayPort cable (1.80 m)
	Power cable (varies by country or region)
	<ul style="list-style-type: none">▪ Safety, Environmental, and Regulatory Information▪ QR card

Product features

The **Alienware AW2526HL/AW2726DL** Gaming monitor has an active matrix, Thin-Film Transistor (TFT), Liquid Crystal Display (LCD), and LED backlight. The monitor features include:

- **AW2526HL:** 622.3 mm (24.5 in.) viewable area (measured diagonally).
- **AW2726DL:** 685.8 mm (27.0 in.) viewable area (measured diagonally).
- **AW2526HL:** 1920 x 1080 resolution, with full-screen support for lower resolutions.
- **AW2726DL:** 2560 x 1440 resolution, with full-screen support for lower resolutions.
- VESA AdaptiveSync Display certification minimizes graphic distortions like screen tearing and stuttering for a smoother, fluid gameplay.
- Supports AMD FreeSync Technology for tear-free, stutter-free, low latency gaming.
- Color gamut of sRGB 99%. (AW2526HL).
- Color gamut of DCI-P3 93%. (AW2726DL).
- Provides tilt, swivel, height, and pivot adjustments for customizable viewing.
- Includes a removable stand and 100 mm VESA mounting holes for flexible mounting options.
- Digital connectivity through one DisplayPort and two HDMI ports. (AW2526HL)
- Digital connectivity through one DisplayPort and one HDMI ports. (AW2726DL)
- Plug-and-play capability if supported by your computer.
- On-Screen Display (OSD) adjustments for ease of setup and screen optimization.
- Security-lock slot.
- Consumes less than 0.3 W power in standby mode.
- This monitor comes with an integrated low blue light screen feature that improves eye comfort by reducing potentially harmful blue light emissions without compromising color. Through the feature, Dell has reduced harmful blue light exposure from 50% to 35%.
- This monitor is certified with TÜV Rheinland Eye Comfort 3.0 with a 3-star rating. It incorporates key technologies that also deliver a flicker-free screen, up to 75 Hz refresh rate, a color gamut of minimum 95% sRGB. The low blue light screen feature is enabled by default on your monitor.
- This monitor uses a low blue light panel. When restored to factory defaults, it complies with TÜV Rheinland's hardware low blue light certification (Category 3).

Blue light ratio:

The ratio of light in the range from 415nm-455nm compared to 400nm-500nm is less than 50%.

Table 2. Blue light ratio.

Category	Blue light ratio
1	≤20%
2	20% < R ≤ 35%
3	35% < R ≤ 50%

- Decreases the level of hazardous blue light that is emitted from the screen to make viewing more comfortable for your eyes without distorting color accuracy.
- ⚠ WARNING: The possible long-term effects of blue light emission from the monitor may damage the eyes, including but is not limited to eye fatigue and digital eye strain. The low blue light screen feature is designed to reduce the amount of blue light that is emitted from the monitor to optimize eye comfort.**

About TÜV Rheinland Eye Comfort 3.0

TÜV Rheinland Eye Comfort 3.0 certification program presents a consumer-friendly star rating scheme to the display industry promoting eye wellness from safety to eye care. Compared to existing certifications, the 5-star-rating program adds rigorous testing requirements on overall eye care attributes such as low blue-light, flicker-free, refresh rate, color gamut, color accuracy, and ambient light sensor performance. It lays out requirement metrics and rates the product performance on five levels, and the sophisticated technical assessment process provides consumers and buyers with indicators that are easier to judge.

The eye wellness factors being considered remain constant, however, the standards for the various star ratings are different. The higher the star rating, the more stringent the standards. The table below lists the major eye comfort requirements which apply in addition to the basic eye comfort requirements (such as pixel density, uniformity of luminance and color, and freedom of movement).

For more information around TÜV Eye Comfort certification, see:

[Eye Comfort Certification](#)



Table 3. Eye Comfort 3.0 Requirements and Star Rating Scheme for Monitors.

Category	Test item	Star Rating Scheme		
		3-star	4-star	5-star
Eye Care	Low Blue Light	TÜV Hardware LBL Category III ($\leq 50\%$) or Software LBL solution ¹	TÜV Hardware LBL Category II ($\leq 35\%$) or Category I ($\leq 20\%$)	TÜV Hardware LBL Category II ($\leq 35\%$) or Category I ($\leq 20\%$)
	Flicker Free	TÜV Flicker Reduced or TÜV Flicker Free	TÜV Flicker Reduced or TÜV Flicker Free	Flicker Free
Ambient Light Management	Ambient Light Sensor performance	No sensor	No sensor	Ambient light sensor
	Intelligent CCT control	No	No	Yes
	Intelligent Luminance control	No	No	Yes
Image quality	Refresh Rate	≥ 60 Hz	≥ 75 Hz	≥ 120 Hz
	Luminance uniformity	Luminance uniformity $\geq 75\%$		
	Color Uniformity	Color uniformity $\Delta u'v' \leq 0.02$		
	Freedom of movement	Luminance changes shall decrease less than 50%; The color shift shall be less than 0.01.		
	Gamma difference	Gamma difference $\leq \pm 0.2$	Gamma difference $\leq \pm 0.2$	Gamma difference $\leq \pm 0.2$
	Wide color gamut ²	NTSC ³ Min.72% (CIE 1931) or sRGB ⁴ Min 95% (CIE 1931)	sRGB ⁴ Min.95% (CIE 1931)	DCI-P3 ⁵ Min. 95% (CIE 1976) & sRGB ⁴ Min.95% (CIE 1931) or Adobe RGB ⁶ Min.95% (CIE 1931) & sRGB ⁴ Min.95% (CIE 1931)
Eye Comfort User Guide	User guide	Yes	Yes	Yes
Remark	<p>¹ Software controls the blue light emission by reducing excessive blue light, resulting in a more yellow tone.</p> <p>² Color gamut describes the availability of colors in the display. Various standards were developed for specific purposes. 100% corresponds to the full color space as defined in the standard.</p> <p>³ NTSC stands for National Television Standards Committee, which developed a color space for the TV system that is used in the United States.</p> <p>⁴ sRGB is a standard red, green, and blue color space that is in use on monitors, printers, and the World Wide Web.</p> <p>⁵ DCI-P3, short for Digital Cinema Initiatives - Protocol 3, is a color space that is used in digital cinema that encompasses a wider range of colors than the standard RGB color space.</p> <p>⁶ Adobe RGB is a color space developed by Adobe Systems that covers a wider range of colors than the standard RGB color model, especially in the cyans and greens.</p>			

Operating system compatibility

- Windows 11 and later*
- macOS*

*Operating system compatibility on Dell and Alienware branded monitors may vary based on factors such as:

- Specific release date(s) when operating system versions, patches, or updates are available.
- Specific release date(s) when Dell and Alienware branded monitor firmware, software application, or driver updates are available on the Dell support website.

Identifying parts and controls

Front view



Figure 1. Front view of the monitor

Table 4. Components and descriptions.

Label	Description	Use
1	Power LED indicator	Solid white light indicates that the monitor is turned on and is functioning. Blinking white light indicates that the monitor is in Standby Mode.

Back view

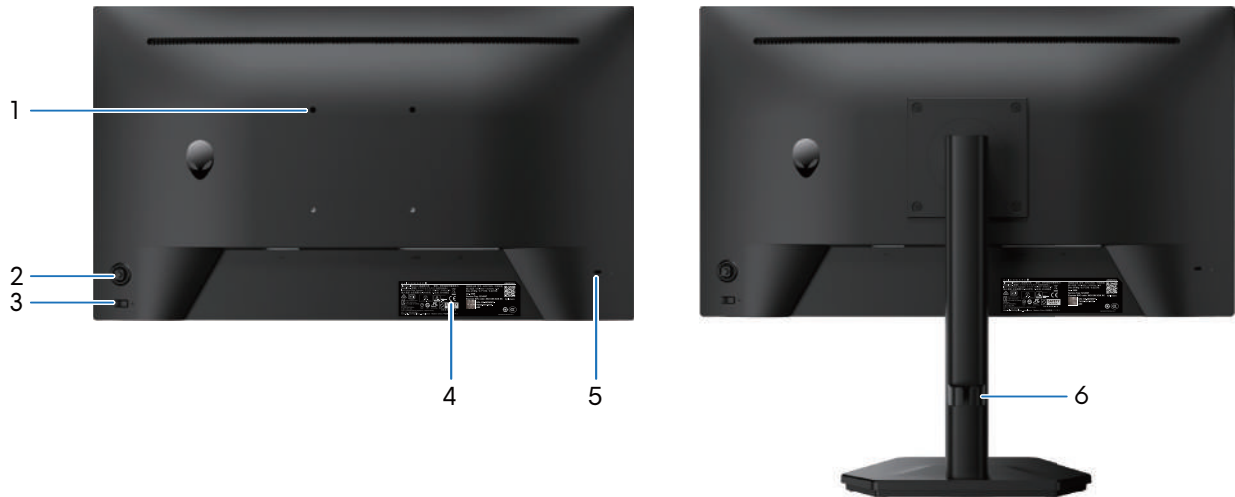


Figure 2. Back view of the monitor

Table 5. Components and descriptions.

Label	Description	Use
1	VESA mounting holes (4) (100 mm x 100 mm) - behind attached VESA cover	Wall mount the monitor using a VESA-compatible wall-mount kit. For more information, see VESA wall mounting (optional) .
2	Joystick button	Use it to control the On-Screen Display (OSD) menu. For more information, see Operating the monitor .
3	Power button	To turn the monitor on or off.
4	Regulatory label (including My Alienware QR code, serial number, and Service Tag label)	Lists the regulatory approvals. See this label if you need to contact Dell for technical support. The Service Tag is a unique alphanumeric identifier that enables Dell service technicians to identify the hardware components in your monitor and access warranty information.
5	Security-lock slot (based on Kensington security slot)	Secure your monitor using a security lock (purchased separately) to prevent unauthorized movement of your monitor. For more information, see Securing your monitor using Kensington lock (optional) .
6	Cable-management slot	Use to organize cables by inserting them through the slot.

Side view



Figure 3. Side view of the monitor

Bottom view

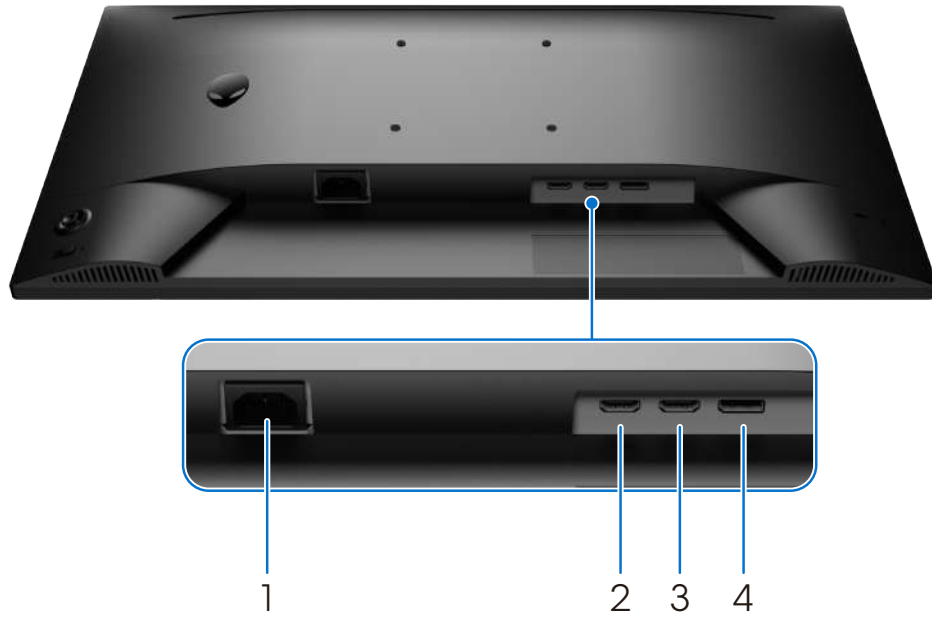




Figure 4. Bottom view of the monitor (AW2526HL)

Table 6. Components and descriptions.

Label	Description	Use
1	 Power connector	Connect the power cable.
2	HDMI1 HDMI1 port	Connect to your computer using the HDMI cable.
3	HDMI2 HDMI2 port	Connect to your computer using the HDMI cable.
4	 DisplayPort	Connect to your computer using the DisplayPort cable.

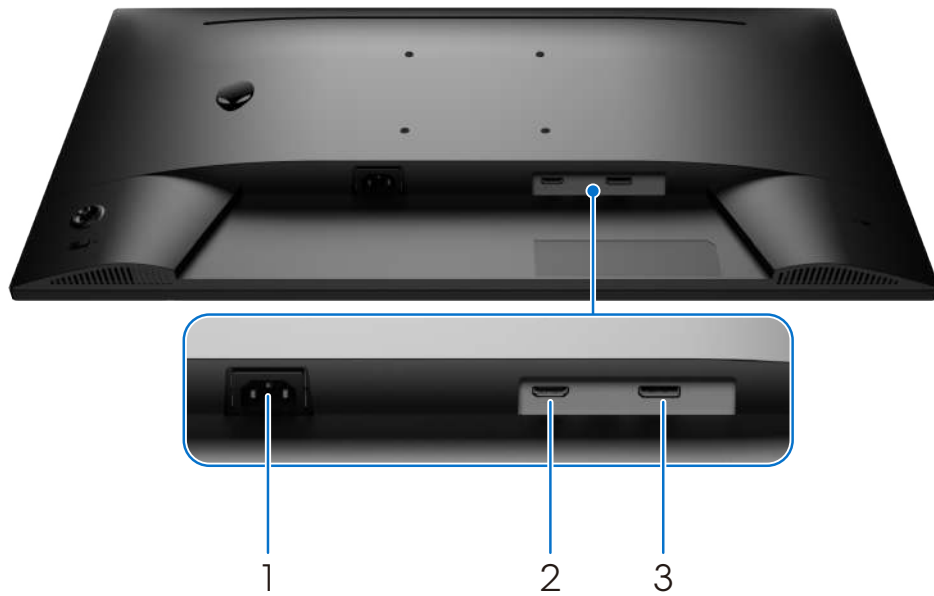




Figure 5. Bottom view of the monitor (AW2726DL)

Table 7. Components and descriptions.

Label	Description	Use
1	 Power connector	Connect the power cable.
2	HDMI HDMI port	Connect to your computer using the HDMI cable.
3	 DisplayPort	Connect to your computer using the DisplayPort cable.

Monitor specifications

Table 8. Monitor specifications.

Description	AW2526HL	AW2726DL
Screen type	Active matrix-TFT LCD	Active matrix-TFT LCD
Panel technology	In-Plane Switching (IPS) Technology	In-Plane Switching (IPS) Technology
Aspect ratio	16:9	16:9
Viewable image dimension		
Diagonal	622.3 mm (24.5 in.)	685.8 mm (27.0 in.)
Active area		
Horizontal	543.74 mm (21.41 in.)	596.74 mm (23.49 in.)
Vertical	302.62 mm (11.91 in.)	335.66 mm (13.22 in.)
Area	164546.60 mm ² (254.99 in. ²)	200301.75 mm ² (310.54 in. ²)
Pixel pitch		
Horizontal	0.2832 mm	0.2331 mm
Vertical	0.2802 mm	0.2331 mm
Pixel per inch (PPI)	90	109
Viewing angle		
Horizontal	178° (typical)	178° (typical)
Vertical	178° (typical)	178° (typical)
Brightness	400 cd/m ² (typical)	400 cd/m ² (typical)
Contrast ratio	1,000:1 (typical)	1,000:1 (typical)
Display screen coating	Anti-Glare (AG) with hard-coating 3H	Anti-Glare (AG) with hard-coating 3H
Response time	<ul style="list-style-type: none"> - 4 ms (gray to gray fast mode) - 2 ms (gray to gray super fast mode) - 1 ms (gray to gray extreme mode) 	<ul style="list-style-type: none"> - 4 ms (gray to gray fast mode) - 2 ms (gray to gray super fast mode) - 1 ms (gray to gray extreme mode)
Color depth	16.70 million colors	1.07 billion colors
Color gamut	sRGB 99% (CIE 1931) (typical)	DCI-P3 93% (CIE 1976) (typical)
Connectivity	<ul style="list-style-type: none"> • 1 DisplayPort 1.4 (HDCP 1.4 and HDCP 2.3) port (supports up to 1920 x 1080, 300 Hz, HDR, AdaptiveSync) • 2 HDMI ports (HDCP 1.4 and HDCP 2.3) (supports up to 1920 x 1080, 240 Hz, HDR, VRR as specified in HDMI 2.1 (TMDS)) 	<ul style="list-style-type: none"> • 1 DisplayPort 1.4 (HDCP 1.4 and HDCP 2.3) port (supports up to 2560 x 1440, 280 Hz, DSC, HDR, AdaptiveSync) • 1 HDMI port (HDCP 1.4 and HDCP 2.3) (supports up to QHD 2560 x 1440, 280 Hz, FRL, HDR, VRR as specified in HDMI 2.1 (TMDS))
Border width (edge of monitor to active area)		
Top	6.97 mm (0.27 in.)	8.37 mm (0.33 in.)
Left/Right	6.97 mm (0.27 in.)	8.38 mm (0.33 in.)
Bottom	13.28 mm (0.52 in.)	14.47 mm (0.57 in.)
Adjustability		
Height adjustable stand	0 mm to 130 mm	0 mm to 130 mm
Tilt	-5° to 21°	-5° to 21°
Swivel	-173° to 173°	-173° to 173°
Pivot	-90° to 90°	-90° to 90°
Cable management	Yes	Yes

Description	AW2526HL	AW2726DL
Security	Security-lock slot (cable lock optional purchase)	Security-lock slot (cable lock optional purchase)

Resolution specifications

Table 9. Resolution specifications.

Description	AW2526HL	AW2726DL
Horizontal scan range	30 kHz to 365 kHz (automatic)	25 kHz to 480 kHz (automatic)
Vertical scan range	48 Hz to 240 Hz (automatic) (HDMI) 48 Hz to 300 Hz (automatic) (DisplayPort)	48 Hz to 280 Hz (automatic)
Maximum preset resolution	1920 x 1080 at 240 Hz (HDMI) 1920 x 1080 at 300 Hz (DisplayPort)	2560 x 1440 at 280 Hz

Supported video modes

Table 10. Supported video modes.

Description	AW2526HL	AW2726DL
Video display capabilities (DisplayPort)	1080p, 720p, 576p, 480p	1080p, 720p, 576p, 480p
Video display capabilities (HDMI)	1080p, 720p, 576p, 480p	2160p, 1080p, 720p, 576p, 480p

Preset display modes

Table 11. DisplayPort preset display modes. (AW2526HL)

Display mode	Horizontal frequency (kHz)	Vertical frequency (Hz)	Pixel clock (MHz)	Sync polarity (Horizontal/Vertical)
VGA 640 x 480	31.47	59.94	25.18	-/-
VGA 640 x 480	37.50	75.00	31.50	-/-
VGA 720 x 400	31.47	70.08	28.32	-/+
SVGA 800 x 600	37.88	60.32	40.00	+/+
SVGA 800 x 600	46.88	75.00	49.50	+/+
XGA 1024 x 768	48.36	60.00	65.00	-/-
XGA 1024 x 768	60.02	75.03	78.75	+/+
DMT 1152 x 864	67.50	75.00	108.00	+/+
WXGA 1280 x 800	49.31	59.91	71.00	+/+
SXGA 1280 x 1024	63.98	60.02	108.00	+/+
SXGA 1280 x 1024	79.98	75.02	135.00	+/+
WSXGA+ 1680 x 1050	65.29	59.95	146.25	-/+
FHD 1920 x 1080	67.50	60.00	148.50	+/+
FHD 1920 x 1080	186.45	165.00	387.81	+/-
FHD 1920 x 1080	278.40	240.00	584.64	+/-
FHD 1920 x 1080	364.50	300.00	772.74	+/-

Table 12. HDMI preset display modes. (AW2526HL)

Display mode	Horizontal frequency (kHz)	Vertical frequency (Hz)	Pixel clock (MHz)	Sync polarity (Horizontal/Vertical)
VGA 640 x 480	31.47	59.94	25.18	-/-
VGA 640 x 480	37.50	75.00	31.50	-/-
VGA 720 x 400	31.47	70.08	28.32	-/+
SVGA 800 x 600	37.88	60.32	40.00	+/+
SVGA 800 x 600	46.88	75.00	49.50	+/+
XGA 1024 x 768	48.36	60.00	65.00	-/-
XGA 1024 x 768	60.02	75.03	78.75	+/+
DMT 1152 x 864	67.50	75.00	108.00	+/+
WXGA 1280 x 800	49.31	59.91	71.00	+/+
SXGA 1280 x 1024	63.98	60.02	108.00	+/+
SXGA 1280 x 1024	79.98	75.02	135.00	+/+
WSXGA+ 1680 x 1050	65.29	59.95	146.25	-/+
FHD 1920 x 1080	67.50	60.00	148.50	+/+
FHD 1920 x 1080	186.45	165.00	387.81	+/-
FHD 1920 x 1080	278.40	240.00	584.64	+/-

Table 13. DisplayPort preset display modes. (AW2726DL)

Display mode	Horizontal frequency (kHz)	Vertical frequency (Hz)	Pixel clock (MHz)	Sync polarity (Horizontal/Vertical)
VESA 640 x 480	31.47	59.94	25.17	-/-
VESA 640 x 480	37.50	75.00	31.50	-/-
IBM 720 x 400	31.47	70.08	28.32	-/+
VESA 800 x 600	37.88	60.32	40.00	+/+
VESA 800 x 600	46.88	75.00	49.50	+/+
VESA 1024 x 768	48.36	60.00	65.00	-/-
VESA 1024 x 768	60.02	75.03	78.75	+/+
VESA 1152 x 864	67.50	75.00	108.00	+/+
VESA 1280 x 720	45.00	59.94	74.25	-/+
VESA 1280 x 800	49.31	59.91	71.00	+/+
VESA 1280 x 960	60.00	60.00	108.00	+/+
VESA 1280 x 1024	63.98	60.02	108.00	+/+
VESA 1280 x 1024	79.98	75.02	135.00	+/+
VESA 1440 x 900	55.94	59.89	106.50	-/+
VESA 1680 x 1050	65.29	59.95	146.25	-/+
VESA 1920 x 1080	67.50	60.00	148.50	+/+
VESA 1920 x 1080	291.58	239.99	606.50	+/-
VESA 1920 x 1080	347.11	279.93	722.00	+/-
VESA 2560 x 1440	88.79	59.95	241.50	+/-
VESA 2560 x 1440	183.00	120.00	497.75	+/-
VESA 2560 x 1440	222.15	143.97	604.25	+/-
VESA 2560 x 1440	282.53	179.96	768.50	+/-
VESA 2560 x 1440	388.51	239.97	1056.75	+/-
VESA 2560 x 1440	414.33	279.96	1126.99	+/-
VESA 2560 x 1440	222.15	143.97	604.25	+/-

Table 14. HDMI preset display modes. (AW2726DL)

Display mode	Horizontal frequency (kHz)	Vertical frequency (Hz)	Pixel clock (MHz)	Sync polarity (Horizontal/Vertical)
VESA 640 x 480	31.47	59.94	25.17	-/-
VESA 640 x 480	37.50	75.00	31.50	-/-
IBM 720 x 400	31.47	70.08	28.32	-/+
VESA 800 x 600	37.88	60.32	40.00	+/+
VESA 800 x 600	46.88	75.00	49.50	+/+
VESA 1024 x 768	48.36	60.00	65.00	-/-
VESA 1024 x 768	60.02	75.03	78.75	+/+
VESA 1152 x 864	67.50	75.00	108.00	+/+
VESA 1280 x 720	45.00	59.94	74.25	-/+
VESA 1280 x 800	49.31	59.91	71.00	+/+
VESA 1280 x 960	60.00	60.00	108.00	+/+
VESA 1280 x 1024	63.98	60.02	108.00	+/+
VESA 1280 x 1024	79.98	75.02	135.00	+/+
VESA 1440 x 900	55.94	59.89	106.50	-/+
VESA 1680 x 1050	65.29	59.95	146.25	-/+
VESA 1920 x 1080	67.50	60.00	148.50	+/+
VESA 1920 x 1080	291.58	239.99	606.50	+/-
VESA 1920 x 1080	347.11	279.93	722.00	+/-
VESA 2560 x 1440	88.79	59.95	241.50	+/-
VESA 2560 x 1440	183.00	120.00	497.75	+/-
VESA 2560 x 1440	217.39	143.97	591.31	+/-
VESA 2560 x 1440	282.53	179.96	768.50	+/-
VESA 2560 x 1440	388.51	239.97	1056.75	+/-
VESA 2560 x 1440	414.33	279.96	1126.99	+/-

NOTE: This monitor supports VESA AdaptiveSync Display, AMD FreeSync Premium.

Electrical specifications

Table 15. Electrical specifications.

Description	AW2526HL	AW2726DL
Video input signals	HDMI/DP, 600 mV for each differential line, 100 Ω input impedance per differential pair	
Input voltage/frequency/current	100 VAC to 240 VAC/50 Hz or 60 Hz \pm 3 Hz/1.5 A (maximum)	
Inrush current	<ul style="list-style-type: none"> • 120 V: 30 A (maximum) at 0°C (cold start) • 240 V: 60 A (maximum) at 0°C (cold start) 	
Power consumption	<ul style="list-style-type: none"> • 0.30 W (Off Mode)¹ • 0.30 W (Standby Mode)¹ • 18 W (On Mode)¹ • 42 W (maximum)² • 19 W (P_{on})³ • 60 kWh (TEC)³ 	<ul style="list-style-type: none"> • 0.30 W (Off Mode)¹ • 0.30 W (Standby Mode)¹ • 25 W (On Mode)¹ • 58 W (maximum)² • 19 W (P_{on})³ • 60 kWh (TEC)³

¹ As defined in EU 2019/2021 and EU 2019/2013.

² Maximum brightness and contrast setting with maximum power loading.

³ P_{on}: Power consumption of On Mode that is measured with reference to the Energy Star test method.

TEC: Total Energy Consumption in kWh that is measured with reference to the Energy Star test method.

This document is informational only and reflects laboratory performance.

Your product may perform differently, depending on the software, components, and peripherals you ordered and you shall have no obligation to update such information.

So, the customer should not rely upon this information in deciding electrical tolerances or otherwise. No warranty as to accuracy or completeness is expressed or implied.

Physical characteristics

Table 16. Physical characteristics.

Description	AW2526HL	AW2726DL
Dimensions (with stand)		
Height (extended)	491.47 mm (19.35 in.)	511.06 mm (20.12 in.)
Height (compressed)	361.47 mm (14.23 in.)	381.06 mm (15.00 in.)
Width	557.69 mm (21.96 in.)	613.50 mm (24.15 in.)
Depth	214.70 mm (8.45 in.)	214.70 mm (8.45 in.)
Dimensions (without stand)		
Height	322.88 mm (12.71 in.)	358.50 mm (14.11 in.)
Width	557.69 mm (21.96 in.)	613.50 mm (24.15 in.)
Depth	48.10 mm (1.89 in.)	48.10 mm (1.89 in.)
Stand dimensions		
Height (extended)	392.61 mm (15.46 in.)	392.61 mm (15.46 in.)
Height (compressed)	348.12 mm (13.71 in.)	348.12 mm (13.71 in.)
Width	265.72 mm (10.46 in.)	265.72 mm (10.46 in.)
Depth	214.70 mm (8.45 in.)	214.70 mm (8.45 in.)
Weight		
Weight with packaging	6.75 kg (14.88 lb)	7.45 kg (16.42 lb)
Weight with stand assembly and cables	4.58 kg (10.10 lb)	5.01 kg (11.05 lb)
Weight without stand assembly (For wall mount or VESA mount considerations - no cables)	2.87 kg (6.33 lb)	3.30 kg (7.28 lb)
Weight of stand assembly	1.44 kg (3.17 lb)	1.44 kg (3.17 lb)

Environmental characteristics

Table 17. Environmental characteristics.

Description	AW2526HL	AW2726DL
Compliant Standards	<ul style="list-style-type: none"> • RoHS-compliant • The monitor is designed with reduced BFR/PVC content; its circuit boards use laminates that are free of BFR and PVC. • Arsenic-free glass and mercury-free for the panel only 	
Temperature		
Operating	0°C to 40°C (32°F to 104°F)	
Non-operating	<ul style="list-style-type: none"> • Storage: -20°C to 60°C (-4°F to 140°F) • Shipping: -20°C to 60°C (-4°F to 140°F) 	
Humidity		
Operating	10% to 80% (non-condensing)	
Non-operating	<ul style="list-style-type: none"> • Storage 5% to 90% (non-condensing) • Shipping 5% to 90% (non-condensing) 	
Altitude		
Operating (maximum)	5,000 m (16,404 ft)	
Non-operating (maximum)	12,192 m (40,000 ft)	
Thermal dissipation	<ul style="list-style-type: none"> • 143.64 BTU/hour (maximum) • 61.56 BTU/hour (On Mode) 	<ul style="list-style-type: none"> • 198.36 BTU/hour (maximum) • 85.50 BTU/hour (On Mode)

Pin assignments

DisplayPort

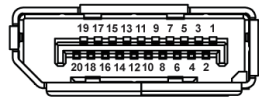


Figure 6. 20-pin DisplayPort

Table 18. Pin assignments - DisplayPort.

Pin number	20-pin side of the connected signal cable
1	ML3 (n)
2	GND
3	ML3 (p)
4	ML2 (n)
5	GND
6	ML2 (p)
7	ML1 (n)
8	GND
9	ML1 (p)
10	ML0 (n)
11	GND
12	ML0 (p)
13	GND
14	GND
15	AUX (p)
16	GND
17	AUX (n)
18	Hot Plug Detect
19	Re-PWR
20	+3.3 V DP_PWR

HDMI 1/HDMI 2 port

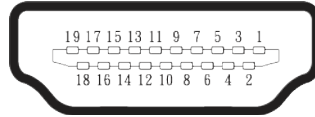


Figure 7. 19-pin HDMI 1/HDMI 2 port

Table 19. Pin assignments - HDMI 1/HDMI 2 port.

Pin number	19-pin side of the connected signal cable
1	TMDS DATA 2+
2	TMDS DATA 2 SHIELD
3	TMDS DATA 2-
4	TMDS DATA 1+
5	TMDS DATA 1 SHIELD
6	TMDS DATA 1-
7	TMDS DATA 0+
8	TMDS DATA 0 SHIELD
9	TMDS DATA 0-
10	TMDS CLOCK+
11	TMDS CLOCK SHIELD
12	TMDS CLOCK-
13	CEC
14	Reserved (N.C. on device)
15	DDC CLOCK (SCL)
16	DDC DATA (SDA)
17	DDC/CEC Ground
18	+5 V POWER
19	HOT PLUG DETECT

Plug-and-Play

You can connect the monitor to any Plug-and-Play compatible computer. The monitor automatically provides the computer with its Extended Display Identification Data (EDID) using Display Data Channel (DDC) protocols so that the computer can configure itself and optimize the monitor settings. Most monitor installations are automatic; you can select different settings as required. For more information about changing the monitor settings, see [Operating the monitor](#).

LCD monitor quality and pixel policy

During the LCD monitor manufacturing process, it is normal for one or more pixels to become fixed in an unchanging state which are hard to see and do not affect the display quality or usability. For more information about Dell Monitor Quality and Pixel Policy, see [Dell Display Pixel Guidelines](#) at [Dell Support Site](#).

Ergonomics

△ **CAUTION: Improper or prolonged usage of a keyboard may result in injury.**

△ **CAUTION: Viewing the monitor screen for extended periods of time may result in eye strain.**

For comfort and efficiency, observe the following guidelines when setting up and using your computer workstation:

- Position your computer so that the monitor and keyboard are directly in front of you as you work. Special shelves are commercially available to help you correctly position your keyboard.
- To reduce the risk of eye strain and neck, arm, back or shoulder pain from using the monitor for long periods of time, it is recommended that you:
 1. Set the distance of the screen between 20 in. to 28 in. (50 cm to 70 cm) from your eyes.
 2. Blink frequently to moisten your eyes or wet your eyes with water after prolonged usage of the monitor.
 3. Take regular and frequent breaks for 20 minutes every two hours.
 4. Look away from your monitor and gaze at a distant object at 20 feet away for at least 20 seconds during the breaks.
 5. Perform stretches to relieve tension in the neck, arms, back and shoulders during the breaks.
- Ensure that the monitor screen is at eye level or slightly lower when you are sitting in front of the monitor.
- Adjust the tilt of the monitor, its contrast, and brightness settings.
- Adjust the ambient lighting around you (such as overhead lights, desk lamps and the curtains, or blinds on nearby windows) to minimize reflections and glare on the monitor screen.
- Use a chair that provides good lower-back support.
- Keep your forearms horizontal with your wrists in a neutral, comfortable position while using the keyboard or mouse.
- Always leave space to rest your hands while using the keyboard or mouse.
- Let your upper arms rest naturally on both sides of the chair.
- Ensure that your feet are resting flat on the floor.
- When sitting, ensure that the weight of your legs is on your feet and not on the front portion of your seat. Adjust the height of your chair or use a footrest if necessary to maintain a proper posture.
- Vary your work activities. Try to organize your work so that you do not have to sit and work for extended periods of time. Try to stand or get up and walk around at regular intervals.
- Keep the area under your desk clear of obstructions and cables or power cables that may interfere with comfortable seating or present a potential trip hazard.

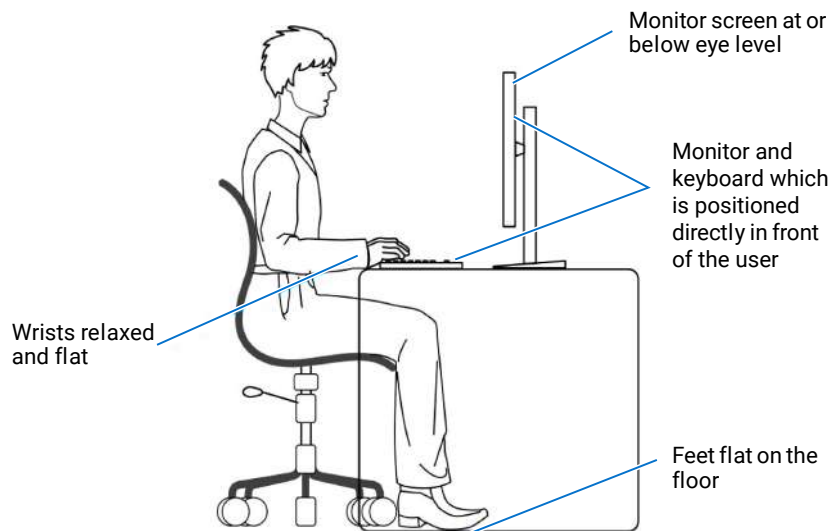


Figure 8. Correct sitting posture while using the monitor

Handling and moving your display

To ensure that the monitor is handled safely when lifting or moving it, follow the guidelines that are mentioned below:

- Before moving or lifting the monitor, turn off your computer and the monitor.
- Disconnect all cables from the monitor.
- Place the monitor in the original box with the original packing materials.
- Hold the bottom edge and the side of the monitor firmly without applying excessive pressure when lifting or moving the monitor.

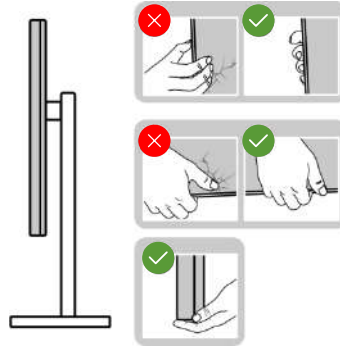


Figure 9. Moving or lifting the monitor

- When lifting or moving the monitor, ensure that the screen is facing away from you. Do not press on the display area to avoid any scratches or damage.

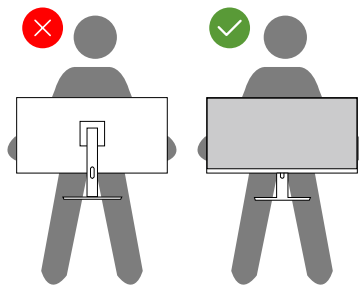


Figure 10. Ensure that the screen is facing away from you

- When transporting the monitor, avoid any sudden shock or vibration to it.
- When lifting or moving the monitor, do not turn the monitor upside down while holding the stand base or stand riser. This may result in accidental damage to the monitor or cause personal injury.

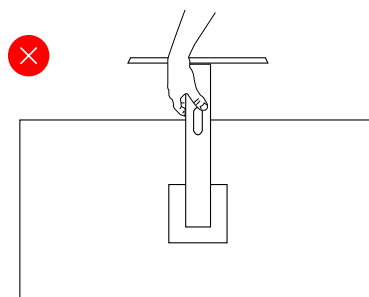


Figure 11. Do not turn the monitor upside down

Maintenance guidelines

Cleaning your monitor

△ **CAUTION:** Read and follow the [Safety instructions](#) before cleaning the monitor.

△ **WARNING:** Before cleaning the monitor, unplug the monitor power cable from the electrical outlet.

For best practices, follow the instructions that are listed below when unpacking, cleaning, or handling your monitor:

- Use a clean cloth that is slightly dampened with water to clean the stand assembly, the screen, and the chassis of your Dell monitor. If available, use a screen-cleaning tissue or solution suitable for cleaning Dell monitors.
- After cleaning the surface of the table, ensure that it is thoroughly dry and free from any moisture or cleaning agent before placing your Dell monitor on it.
 - △ **CAUTION:** Do not use detergents or other chemicals such as benzene, thinner, ammonia, abrasive cleaners, or compressed air.
 - △ **CAUTION:** Using chemicals for cleaning may cause changes in the appearance of the monitor, such as color fading, milky film on the monitor, deformation, uneven dark shade and peeling of screen area.
 - △ **WARNING:** Do not spray the cleaning solution or even water directly on the surface of the monitor. Doing so allows liquids to accumulate at the bottom of the display panel and corrode the electronics resulting in permanent damage. Instead, apply the cleaning solution or water to a soft cloth and then clean the monitor.
- ① **NOTE:** Monitor damages due to improper cleaning methods and the use of benzene, thinner, ammonia, abrasive cleaners, alcohol, compressed air, detergent of any kind leads to a Customer-Induced Damage (CID). CID is not covered under the standard Dell warranty.
- If you notice white powder when you unpack your monitor, wipe it off with a cloth.
- Handle your monitor with care as a darker colored monitor may get scratched and show white scuff marks more than a lighter colored monitor.
- To help maintain the best image quality on your monitor, use a dynamically changing screen saver and turn off your monitor when not in use.

Setting up the monitor

Connecting the stand

△ **CAUTION:** The following steps are important to protect your screen. Follow the instructions to complete the installation.

① **NOTE:** The stand is not installed at the factory when shipped.

① **NOTE:** The following instructions are applicable only for the stand that was shipped with your monitor. If you are attaching a stand that you purchased from any other source, follow the setup instructions that were included with the stand.

1. Remove the stand base and stand riser from the packaging cushion.
2. Align and place the stand riser on the stand base.
3. Open the screw handle at the bottom of the stand base and turn it clockwise to secure the stand assembly.
4. Close the screw handle.

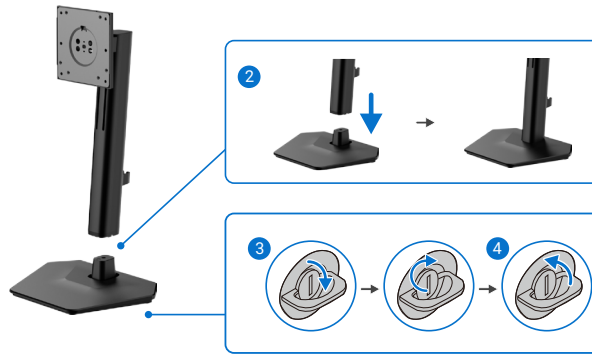


Figure 12. Assemble the stand riser to stand base

5. Align the screw holes on the stand assembly with the screw holes on the display back cover.
6. Use the provided Allen key to install the four screws (M4x10) that secure the stand assembly to the display back cover.

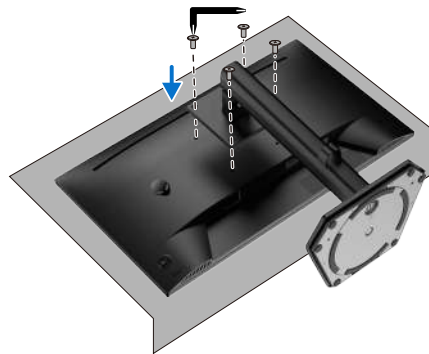


Figure 13. Attach the stand assembly to the display

7. Hold the stand riser and lift the monitor carefully, then place it on a flat surface.
△ **CAUTION: Hold the riser firmly and lift the monitor slowly with both hands to prevent it from slipping or falling.**

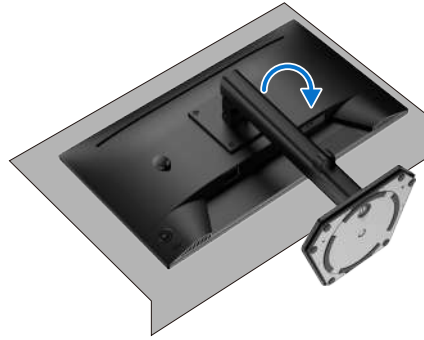


Figure 14. Hold the stand riser and lift the monitor

8. Lift the protective cover from the monitor.



Figure 15. Lift the protective cover from the monitor

Using the tilt, swivel, pivot and height adjustment

Tilt and swivel adjustment

With the stand attached to the monitor, you can tilt and swivel the monitor for the most comfortable viewing angle.

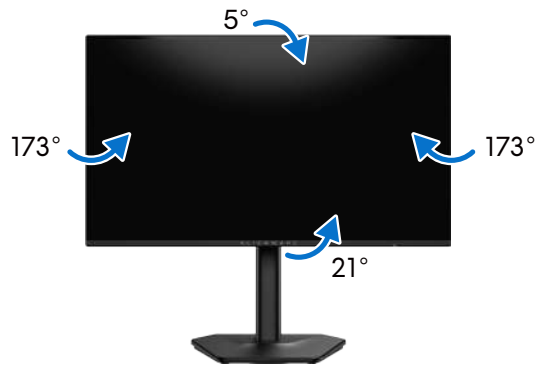


Figure 16. Tilt and swivel adjustment

Height adjustment

① **NOTE:** The stand extends vertically up to 130 mm. The following image illustrates how to adjust the stand vertically.

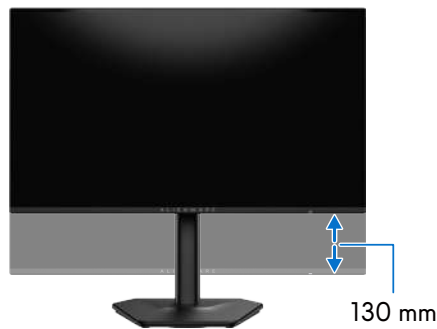


Figure 17. Height adjustment

Pivot adjustment

Before you rotate the display, ensure it is completely extended vertically and completely tilted up to avoid hitting the bottom edge of the monitor.

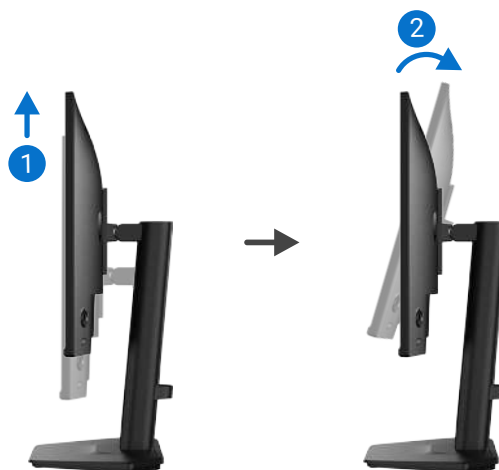


Figure 18. Raising the monitor and tilting upward

Rotate clockwise



Figure 19. Rotate clockwise

Rotate counterclockwise



Figure 20. Rotate counterclockwise

- ① **NOTE:** To use the display rotation feature (landscape or portrait view) on your Dell computer, you need the latest graphics driver. This driver is not included with the monitor. To download it, go to [Dell Support Site](#) and see the Video Drivers section for the most recent updates.
- ① **NOTE:** In portrait mode, you may notice reduced performance when running graphics-intensive applications such as 3D games.

Adjusting the rotation display settings of your system

After rotating the monitor, complete the steps below to adjust your computer's display rotation settings.

- ① **NOTE:** If you are using the monitor with a non-Dell computer, go to the graphics driver website or your computer manufacturer's website for instructions on rotating the content on your display.

To adjust the display rotation settings:

1. Right-click the desktop and click **Properties**.
 2. Select the **Settings** tab and click **Advanced**.
 3. If you have an AMD graphics card, select the **Rotation** tab and set the preferred rotation.
 4. If you have an NVIDIA graphics card, click the **NVIDIA** tab. In the left-hand column, select **NVRotate**, and then choose your preferred rotation.
 5. If you have an Intel graphics card, click the **Intel** graphics tab, click **Graphic Properties**, select the **Rotation** tab, and then choose your preferred rotation.
- ① **NOTE:** If you do not see the rotation option or it is not working correctly, go to [Dell Support Site](#) and download the latest driver for your graphics card.

Organizing your cables

After connecting all the required cables to your monitor and computer (see [Connecting your monitor](#)), route the cables through the cable-management slot on the stand.

If a cable does not reach your computer when routed it through the slot, then connect the cable directly to the computer instead.



Figure 21. Organizing cables

Connecting your monitor

- ⚠ **WARNING:** Before you begin any of the procedures in this section, follow the [Safety instructions](#).
- ⚠ **WARNING:** For your safety, ensure that the grounded power outlet you use is easily accessible and located as close to the equipment as possible. To disconnect power firmly grasp the plug and disconnect the power cable from the outlet. Never pull on the cable.
- ① **NOTE:** If you use non-Dell cables, Dell does not guarantee video quality or performance. For optimal results, use the Dell-supplied cables included in the box.
- ① **NOTE:** Route the cables through the cable-management slot before connecting them.
- ① **NOTE:** Do not connect all the cables to the computer simultaneously.
- ① **NOTE:** The images are for illustration purposes only. The appearance of the computer may vary.

To connect your monitor to the computer:

1. Turn off your computer and disconnect the power cable.
2. Connect the HDMI/DisplayPort cable from your monitor to the computer.
3. Connect the power cables of your computer and monitor into a wall outlet.
4. Turn on your monitor.
5. Select the correct input source from the OSD Menu on your monitor and then turn on your computer.

Connecting the DisplayPort cable



Figure 22. Connecting the DisplayPort cable

Connecting the HDMI cable (optional)

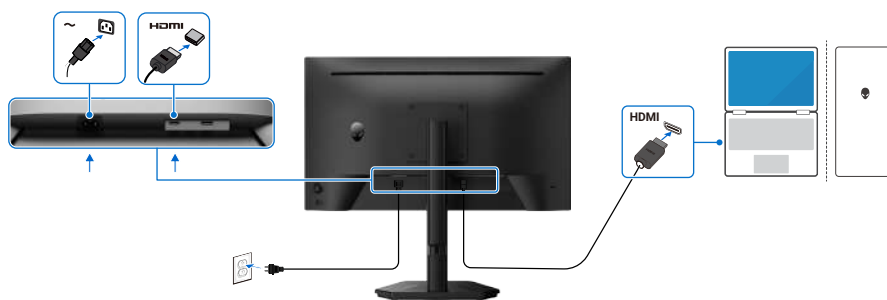


Figure 23. Connecting the HDMI cable

Securing your monitor using Kensington lock (optional)

The security-lock slot is at the bottom of the monitor (see [Security-lock slot](#)). Secure your monitor to a table using the Kensington security lock.

For more information about using the Kensington lock (purchased separately), see the documentation that is shipped with the lock.

① **NOTE:** The following image is for illustration only. The appearance of the lock may vary.

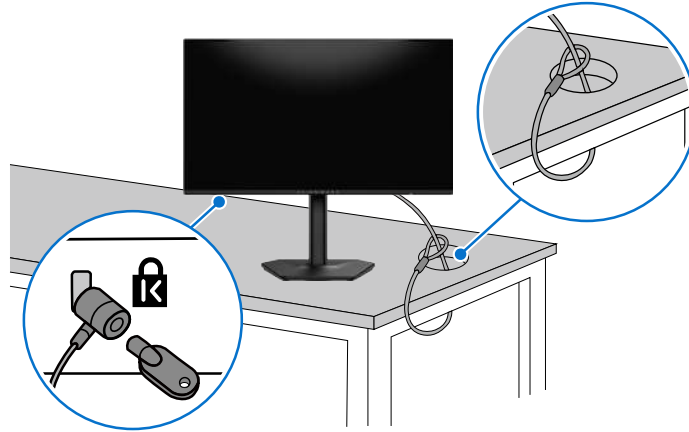


Figure 24. Using Kensington lock

Removing the monitor stand

- △ **CAUTION:** To prevent scratches on the LCD screen when removing the stand, ensure that the monitor is placed on a soft, clean surface and handle it carefully.
- △ **CAUTION:** The following instructions are applicable only for the stand that is shipped with your monitor. If you are removing a stand that you purchased from any other source, follow the instructions that are included with the stand.

To remove the stand:

1. Turn off the monitor.
2. Disconnect all the cables from the computer.
3. Disconnect the cables from the monitor and slide them out through the cable-management slot on the stand riser.
4. Place the monitor on a soft cloth or cushion.
5. Using the Allen key, remove the four screws (M4x10) that secure the stand assembly to the display back cover.
6. Lift the stand assembly up and away from the monitor.

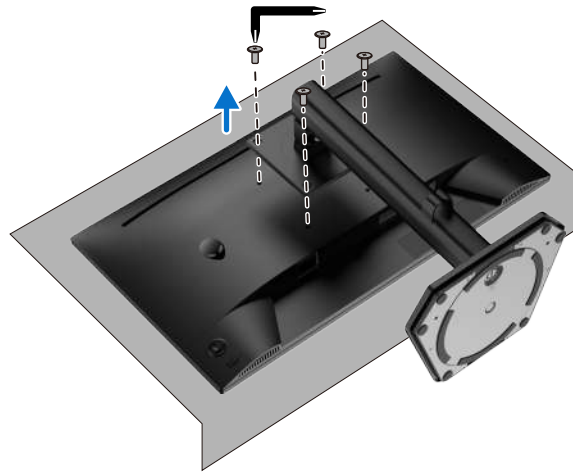


Figure 25. Removing the monitor stand

VESA wall mounting (optional)



Figure 26. VESA wall mounting

- ① **NOTE:** Use four screws (M4x10) to connect the wall-mounting bracket to the monitor. Refer to the instructions provided with the VESA-compatible wall-mounting kit.

1. Place the display on a soft cloth or cushion at the edge of the desk.
2. Remove the stand. See [Removing the monitor stand](#).
3. Attach the mounting bracket from the wall-mounting kit to the monitor.
4. Mount the monitor on the wall. For more information, see the documentation that shipped with the wall-mounting kit.

- ① **NOTE:** Use only UL-, CSA-, or GS-listed wall mount brackets with a minimum weight capacity of 11.48 kg (AW2526HL) or 13.20 kg (AW2726DL).

Operating the monitor

Turn on the monitor

Press the power button to turn on the monitor.

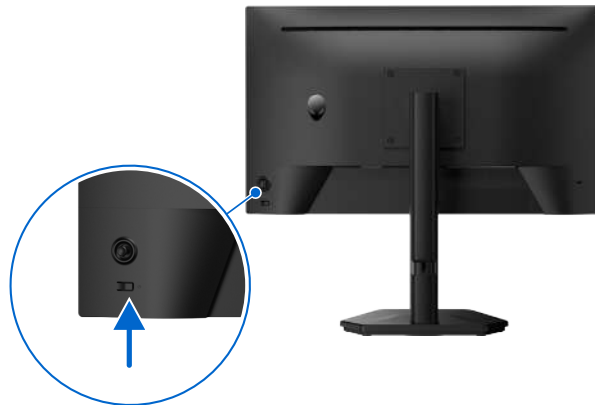


Figure 27. Turn on the monitor

Using the joystick control

Use the joystick control at the bottom of the monitor to make On-Screen Display (OSD) adjustments.

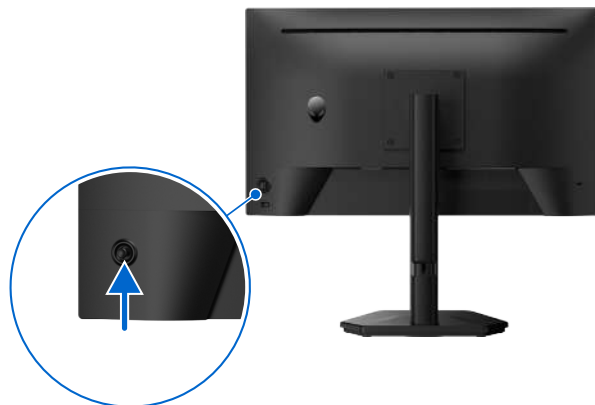






Figure 28. Using the joystick control

Table 20. Using the joystick control.

Joystick	Description
	<ul style="list-style-type: none">When the OSD menu is displayed, press the joystick button to confirm the selection or save the settings.When the OSD menu is off, press the joystick button to launch the OSD main menu. See Accessing the Menu Launcher.
	<ul style="list-style-type: none">For 4-way (left, right, up, and down) directional navigation.Toggles through the menu items.Increases or decreases the parameters of a selected menu item.
	Selects and enters the submenu.
	Returns to the upper-level menu or exits from the current menu.

Accessing the Menu Launcher

When you move or press the joystick button, the Menu Launcher appears at the bottom center of the screen, allowing you to access the OSD menu and shortcut functions.

To select a function, move the joystick button.

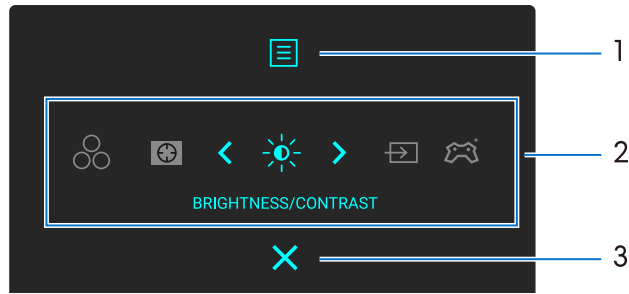









Figure 29. On-Screen Display (OSD) menu

The following table describes the Menu Launcher functions:

Table 21. Description of the Menu Launcher functions.

Label	Icon	Description
1	 MENU	Use this MENU button to launch the On-Screen Display (OSD) and select the OSD menu. See Accessing the menu system .
2	<p>When you move the joystick button to the left or right to toggle through the shortcut functions, the selected item is highlighted and shifted to the center position. Press the joystick button to enter its submenu and make adjustments by moving the joystick button.</p> <p>NOTE: You can set your preferred shortcut keys. For more information, see Personalize.</p>  PRESET MODES	To choose a preferred color mode from the list of PRESET MODES .
	 DARK STABILIZER	To access the DARK STABILIZER adjustment slider.
	 BRIGHTNESS/ CONTRAST	To access the adjustment sliders of brightness and contrast.
	 INPUT SOURCE	To choose an input source from the list of video signals that may be connected to your monitor.
	 GAME ENHANCE MODE	To choose a function to enhance your gameplay experience.
3	 EXIT	Use this button to go back to the main menu or EXIT the OSD main menu.

When the Menu Launcher is on, the OSD Status Bar appears at the top in the center of the screen, displaying the current settings of some OSD functions.

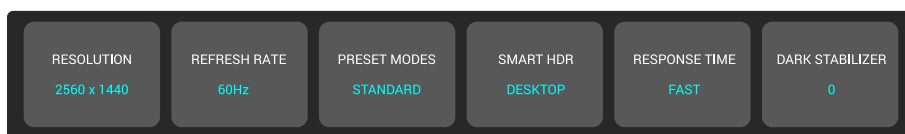


Figure 30. OSD Status Bar


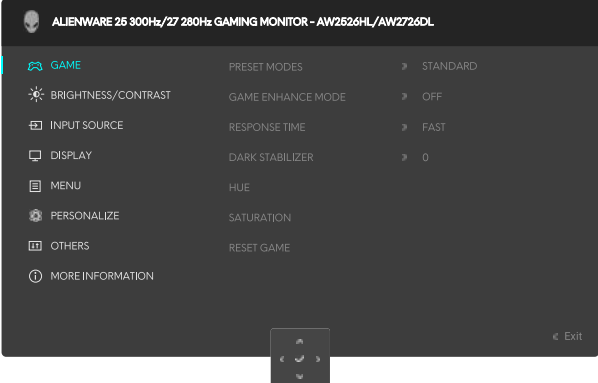
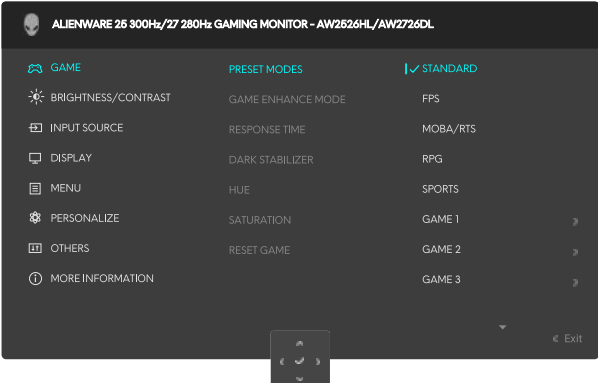
Using the On-Screen Display (OSD) menu


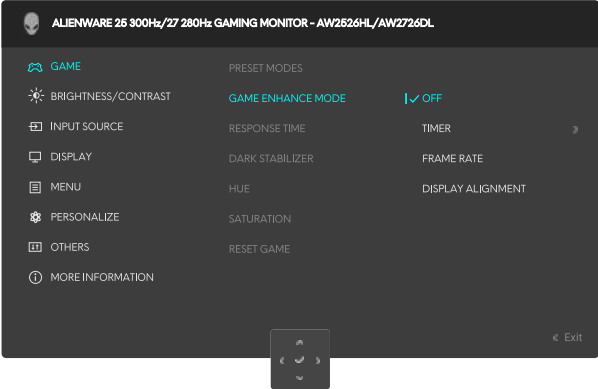
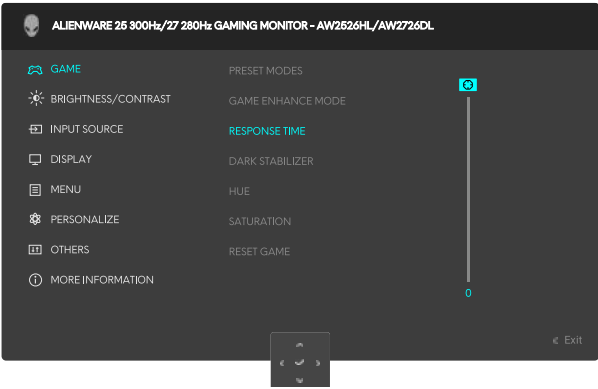
Accessing the menu system



After you change the settings, press the joystick button to save the changes before proceeding to another menu or exiting the OSD menu.


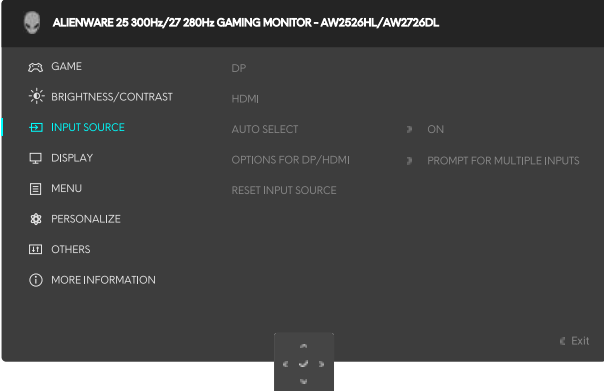

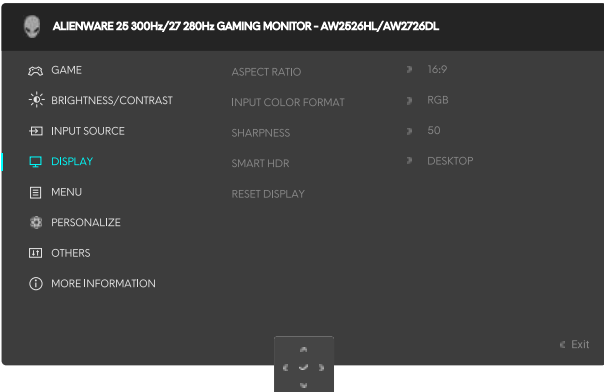
NOTE: To exit the current menu item and return to the previous menu, move the joystick button to the left.


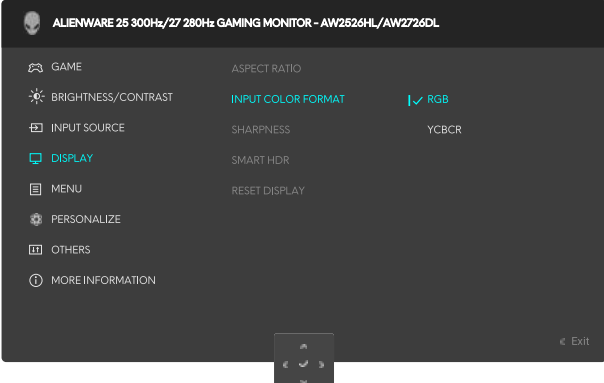
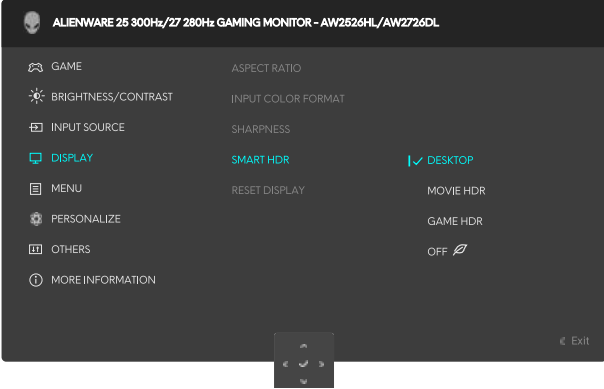

Table 22. OSD menu description.


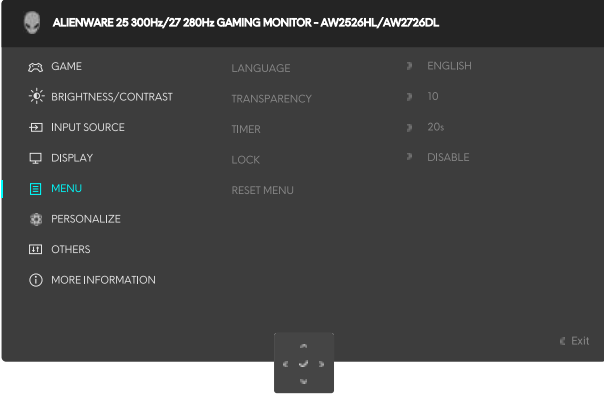
Icon	Menu and submenus	Description
	GAME	<p>Use this menu to personalize your visual gameplay experience.</p> 
	PRESET MODES	<p>Allows you to choose a preset color mode or create your own color modes.</p>  <ul style="list-style-type: none"> • STANDARD: Loads the default color setting of the monitor. This is the default preset mode. • FPS: Loads color settings ideal for First-Person Shooter (FPS) games. • MOBA/RTS: Loads color settings ideal for Multiplayer Online Battle Arena (MOBA) and Real-Time Strategy (RTS) games. • RPG: Loads color settings ideal for Role-Playing Games (RPG). • SPORTS: Loads color settings ideal for sports games. • GAME 1/GAME 2/GAME 3: Enables you to customize the settings of RESPONSE TIME, GAIN, OFFSET, HUE, SATURATION, and DARK STABILIZER for your gaming needs. • WARM: Presents colors at lower color temperatures. The screen appears warmer with a red/yellow tint. • COOL: Presents colors at higher color temperatures. The screen appears cooler with a blue tint. • CUSTOM COLOR: Enables you to manually adjust the color settings. Use the joystick button to adjust GAIN, OFFSET, HUE, and SATURATION to create your own preset color modes. <p>NOTE: This feature is disabled when SMART HDR is activated and HDR content is displayed.</p>


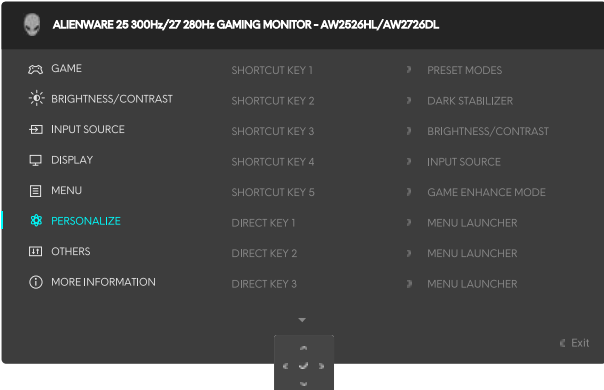
Icon	Menu and submenus	Description
	GAME ENHANCE MODE	<p>The feature offers three functions to enhance your gameplay experience.</p>  <ul style="list-style-type: none"> • OFF: To disable the functions under Game Enhance Mode. • TIMER: To disable or enable the timer at the upper left corner of the display. The timer shows the time that is elapsed since the game starts. Select an option from the time-interval list to keep you aware of the remaining time. • FRAME RATE: To display the current frames per second when playing games. The higher the rate, the smoother the motion appears. • DISPLAY ALIGNMENT: To help ensure the perfect alignment of the video contents from multiple displays. Pressing the joystick button again exits the DISPLAY ALIGNMENT mode.
	RESPONSE TIME	<p>Allows you to set the response time to FAST, SUPER FAST or EXTREME.</p>
	DARK STABILIZER	<p>The feature improves the visibility in the dark gaming scenarios. The higher the value (between 0 to 3), the better visibility in the dark area of the display image.</p>  <p>NOTE: This feature is disabled when SMART HDR is activated and High Dynamic Range (HDR) content is displayed.</p>
	HUE	<p>This feature can shift the color of the video image to green or purple. This is used to adjust the wanted flesh-tone color.</p> <p>Use the joystick button to adjust the hue level from 0 to 100.</p> <p>Higher levels increase the green shade of the video image, while lower levels increase the purple shade of the video image.</p> <p>NOTE: This feature is available only when you select FPS, MOBA/RTS, SPORTS, or RPG preset mode.</p>
	SATURATION	<p>This feature can adjust the color saturation of the video image.</p> <p>Use the joystick button to adjust the saturation level from 0 to 100.</p> <p>Higher levels increase the colorful appearance of the video image, while lower levels increase the monochrome appearance of the video image.</p> <p>NOTE: This feature is available only when you select FPS, MOBA/RTS, SPORTS, or RPG preset mode.</p>
	RESET GAME	<p>Resets all settings under the GAME menu to the factory defaults.</p>


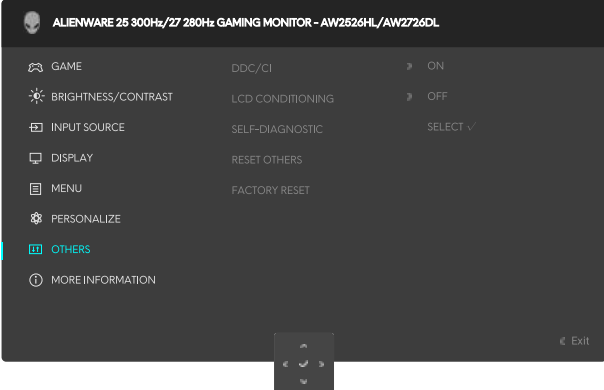
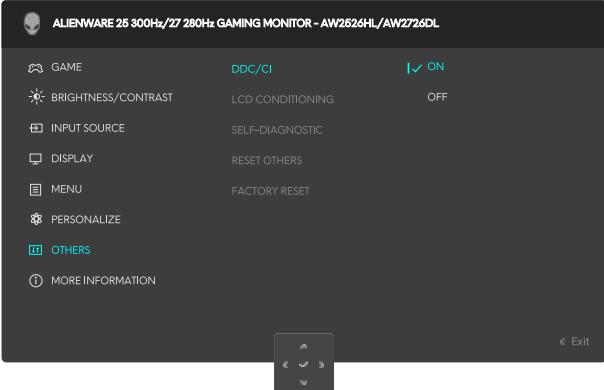

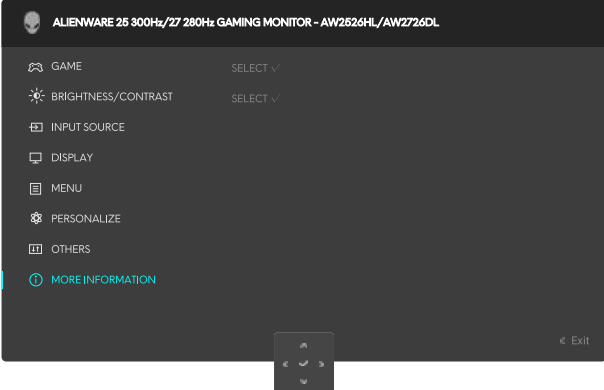
Icon	Menu and submenus	Description
	BRIGHTNESS/ CONTRAST	<p>Use this menu to activate BRIGHTNESS/CONTRAST adjustment.</p> 
	BRIGHTNESS	<p>BRIGHTNESS adjusts the luminance of the backlight.</p> <p>Move the joystick button to adjust the brightness level (from 0 to 100).</p> <p>(i) NOTE: Manual adjustment of BRIGHTNESS is disabled when SMART HDR is activated and HDR content is displayed.</p>
	CONTRAST	<p>Adjust BRIGHTNESS first, and then adjust CONTRAST only if further adjustment is necessary.</p> <p>Move the joystick button to adjust the contrast level (from 0 to 100).</p> <p>The CONTRAST feature adjusts the degree of difference between darkness and lightness on the monitor screen.</p> <p>(i) NOTE: Manual adjustment of CONTRAST is disabled when SMART HDR is activated and HDR content is displayed.</p>

Icon	Menu and submenus	Description
	INPUT SOURCE	Use the input source menu to select between the different video signals that may be connected to your monitor. 
	DP	Select the DP input when you are using the DisplayPort (DP) connector. Press the joystick button to confirm the selection.
	HDMI 1 (AW2526HL)	Select the HDMI 1 or HDMI 2 input when you are using the HDMI connector. Press the joystick button to confirm the selection.
	HDMI 2 (AW2526HL)	
	HDMI (AW2726DL)	Select the HDMI input when you are using the HDMI connector. Press the joystick button to confirm the selection.
	AUTO SELECT	Automatically scans for available input sources. Press the joystick button to confirm the selection.
	OPTIONS FOR DP/HDMI	Allows you to set this feature to: <ul style="list-style-type: none"> • PROMPT FOR MULTIPLE INPUTS: Always displays the “Switch to DP/HDMI Video Input” message for you to choose whether to switch or not. • ALWAYS SWITCH: Always switches to DP/HDMI video input (without asking) when the DisplayPort or HDMI cable is connected. • OFF: Never automatically switches to DP/HDMI video input when the DisplayPort or HDMI cable is connected. Press the Joystick button to confirm the selection. <i>(i)</i> NOTE: This feature is disabled when AUTO SELECT is set to OFF .
	RESET INPUT SOURCE	Resets all settings under the INPUT SOURCE menu to the factory defaults.
	DISPLAY	Use the DISPLAY menu to adjust the images. 
	ASPECT RATIO	Adjusts the image ratio to 16:9 , AUTO RESIZE or 4:3 .

Icon	Menu and submenus	Description
	INPUT COLOR FORMAT	<p>Allows you to set the video input mode to:</p> <ul style="list-style-type: none"> • RGB: Select this option if your monitor is connected to a computer or a media player that supports RGB output. • YCbCr: Select this option if your media player supports only YCbCr output. 
	SHARPNESS	<p>This function can make the image look sharper or softer. Move the joystick button to adjust the sharpness level from 0 to 100.</p>
	SMART HDR	<p>The SMART HDR (High Dynamic Range) feature enhances the display output by optimally adjusting contrast and the ranges of color and luminosity to resemble true-to-life visuals.</p>  <ul style="list-style-type: none"> • DESKTOP: For using the monitor with a desktop computer. • MOVIE HDR: For the playback of HDR video content. • GAME HDR: For playing HDR-compatible games. It displays more realistic scenes and makes the gaming experience immersive and entertaining. • OFF : Disable SMART HDR by selecting OFF. <p>(i) NOTE: When activating and deactivating SMART HDR, a blank screen is expected (for about 5 seconds). This is normal behavior as the monitor changes the display mode. Do not power on/off the monitor.</p> <p>(i) NOTE: When the monitor is processing HDR content, PRESET MODES, DARK STABILIZER, BRIGHTNESS, and CONTRAST are disabled.</p>
RESET DISPLAY	<p>Resets all settings under the DISPLAY menu to the factory defaults.</p>	

Icon	Menu and submenus	Description
	MENU	<p>Select this option to adjust the settings of the OSD, such as the languages of the OSD, the amount of time the menu remains on screen and so on.</p> 
	LANGUAGE	<p>Set the OSD display language to one of the eight languages:</p> <ul style="list-style-type: none"> • ENGLISH • ESPAÑOL • FRANÇAIS • DEUTSCH • PORTUGUÊS (BRASIL) • РУССКИЙ • 简体中文 • 日本語
	TRANSPARENCY	<p>Select this option to change the menu transparency by moving the joystick button (from 0 to 100).</p>
	TIMER	<p>Sets the time that the OSD will remain active after the last time you pressed a button. Move the joystick button to adjust the slider in 1 second increments, from 5 to 60 seconds.</p>
	LOCK	<p>Select this option to lock the monitor control buttons to prevent access to the OSD menu and/or power button.</p> <ul style="list-style-type: none"> • MENU BUTTONS: The OSD menu settings are locked and not accessible. • POWER BUTTON: The power button is locked. • MENU + POWER BUTTONS: The OSD menu settings are not accessible, and the power button is locked. • DISABLE: Disable lock function.
	RESET MENU	<p>Resets all settings under the MENU to the factory defaults.</p>

Icon	Menu and submenus	Description
	PERSONALIZE	
	SHORTCUT KEY 1	Allows you to choose a feature from the provided list and set it as a shortcut key. Press the joystick button to confirm the selection.
	SHORTCUT KEY 2	<ul style="list-style-type: none"> • PRESET MODES • GAME ENHANCE MODE
	SHORTCUT KEY 3	<ul style="list-style-type: none"> • DARK STABILIZER • BRIGHTNESS/CONTRAST
	SHORTCUT KEY 4	<ul style="list-style-type: none"> • INPUT SOURCE • ASPECT RATIO
	SHORTCUT KEY 5	<ul style="list-style-type: none"> • SMART HDR • DISPLAY INFO
	DIRECT KEY 1	Allows you to choose a feature from the provided list and set it as a direct key. Press the joystick button to confirm the selection.
	DIRECT KEY 2	<ul style="list-style-type: none"> • OFF • MENU LAUNCHER • PRESET MODES • GAME ENHANCE MODE
	DIRECT KEY 3	<ul style="list-style-type: none"> • DARK STABILIZER • BRIGHTNESS • CONTRAST • INPUT SOURCE
	DIRECT KEY 4	<ul style="list-style-type: none"> • ASPECT RATIO • SMART HDR • DISPLAY INFO
POWER LED	Allows you to select ON IN ON MODE or OFF IN ON MODE to set the power LED indicator to save energy.	
RESET PERSONALIZATION	Resets all settings under the PERSONALIZE menu to the factory defaults.	

Icon	Menu and submenus	Description
	OTHERS	<p>Changes the OSD settings, such as the DDC/CI, LCD CONDITIONING, SELF-DIAGNOSTIC and so on.</p> 
	DDC/CI	<p>DDC/CI (Display Data Channel/Command Interface) allows you to adjust the monitor settings using software on your computer. Select OFF to turn off this feature.</p> <p>Enable this feature for the best user experience and optimum performance of your monitor.</p> 
	LCD CONDITIONING	<p>Helps reduce minor cases of image retention. Depending on the degree of image retention, the program may take some time to run. To start LCD CONDITIONING, select ON.</p>
	SELF-DIAGNOSTIC	<p>Allows you to check if your monitor is functioning properly.</p>
	RESET OTHERS	<p>Resets all settings under the OTHERS menu to the factory preset values.</p>
	FACTORY RESET	<p>Resets all OSD settings to the factory defaults.</p>
	MORE INFORMATION	<p>Select this option for DISPLAY INFORMATION and ALIENWARE MONITOR SUPPORT.</p> 
	DISPLAY INFO	<p>Displays current settings, firmware version, and Service Tag of your monitor.</p>
	ALIENWARE MONITOR SUPPORT	<p>To access the general monitor support materials for your monitor, use your smartphone to scan the QR code.</p>

OSD warning message

You see the following message when the monitor does not support a particular resolution mode:

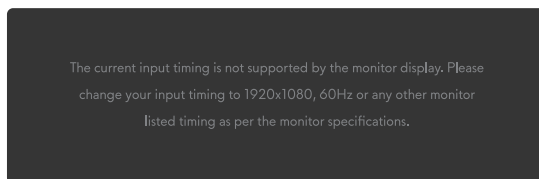


Figure 31. Warning message if a particular resolution mode is not supported (AW2526HL)

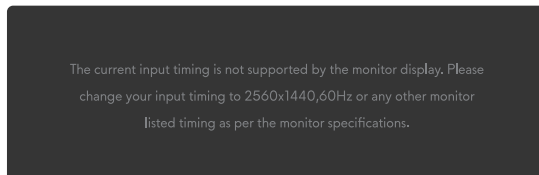


Figure 32. Warning message if a particular resolution mode is not supported (AW2726DL)

This means that the monitor cannot synchronize with the signal that it is receiving from the computer. See [Monitor specifications](#) for the horizontal and vertical frequency ranges supported by this monitor. The recommended resolution is **1920 x 1080 (AW2526HL)** or **2560 x 1440 (AW2726DL)**.

① **NOTE:** The message may vary slightly depending on the connected input signal.

You see the following message before the **DDC/CI** feature is disabled:

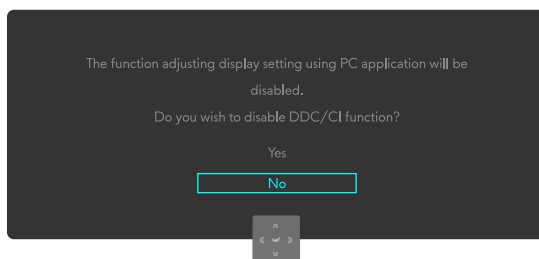


Figure 33. Warning message of the DDC/CI

You see the following message when you increase the **BRIGHTNESS** level above the factory default setting for the first time:

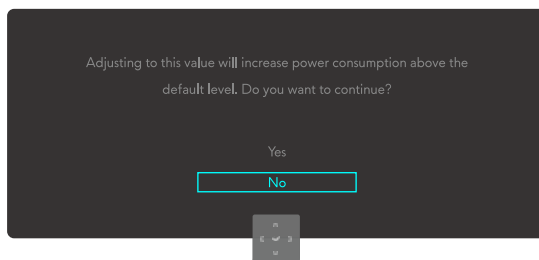


Figure 34. Warning message of increasing the Brightness level

① **NOTE:** If you select **Yes**, the message will not appear the next time that you change the **BRIGHTNESS** setting.

You see the following message when you set **PRESET MODES** to **FPS, MOBA/RTS,** or **SPORTS** for the first time:

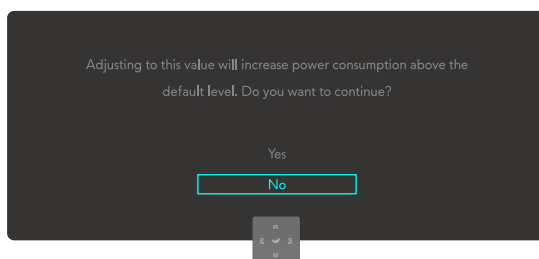


Figure 35. Warning message of setting Preset Modes

① **NOTE:** If you select **No**, the **BRIGHTNESS** level changes to 75% for these **PRESET MODES**.

You see the following message when you change the default setting of power-saving features to **SMART HDR** for the first time after factory reset:

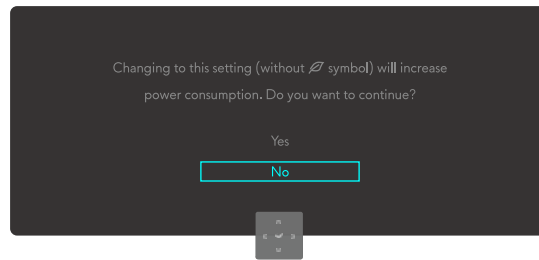


Figure 36. Warning message of changing the default setting

① **NOTE:** If you select **Yes** for either of the features that are mentioned above, the message will not appear the next time you change the settings of these features. When you perform a factory reset, the message appears again.

You see the following message when the monitor enters the **Standby Mode**:

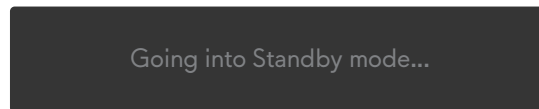


Figure 37. Warning message of entering Standby Mode

① **NOTE:** The message may vary slightly depending on the connected input signal.

Activate the computer and wake up the monitor to gain [Accessing the Menu Launcher](#).

The OSD functions only in the normal operation mode. You see the following message if you press the joystick button during the Standby Mode depending on the selected input:

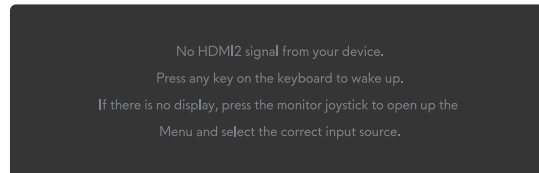


Figure 38. Warning message for accessing the Menu Launcher

① **NOTE:** The message may vary slightly depending on the connected input signal.

Activate the computer and wake up the monitor to gain [Accessing the Menu Launcher](#).

You see the following message if **DP**, **HDMI 1**, or **HDMI 2 (AW2526HL)** input is selected and the corresponding cable is not connected:

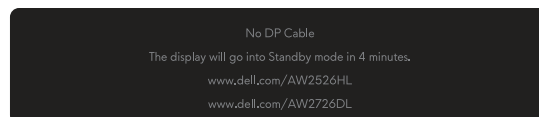


Figure 39. Warning message for no DP cable

or



Figure 40. Warning message for no HDMI 1 cable

or

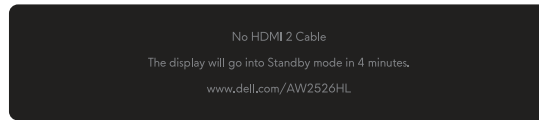


Figure 41. Warning message for no HDMI 2 cable (AW2526HL)

① **NOTE:** The message may vary slightly depending on the selected input signal.

You see the following message when **Factory Reset** is selected:

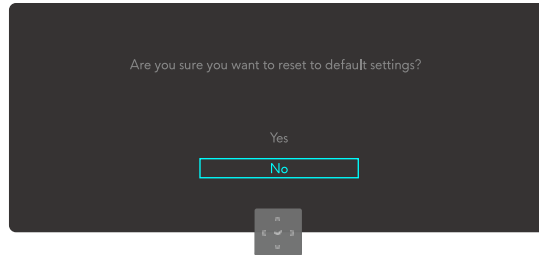


Figure 42. Warning message for Factory Reset

For more information, see [Troubleshooting](#).

Locking the control buttons

You can lock the monitor control buttons to prevent access to the OSD menu and/or power button.

1. Move and hold the joystick button up/down/left/right for about 4 seconds until a menu appears.
2. Move the joystick button to select one of the following options:



: The OSD menu settings are locked and not accessible.




: The power button is locked.



: The OSD menu settings are not accessible, and the power button is locked.

3. Press the joystick button to confirm the configuration.

To unlock, move and hold the joystick button up/down/left/right for about 4 seconds until a menu appears on the screen, and then select  to unlock and close the menu.

Setting the maximum resolution

① **NOTE:** The steps may vary slightly depending on the version of Windows you have.

To set the maximum resolution for the monitor:

In Windows 10 and Windows 11:

1. Right-click the desktop and click **Display settings**.
2. If you have more than one monitor connected, ensure to select **AW2526HL/AW2726DL**.
3. Click the **Display Resolution** dropdown list and select **1920 x 1080 (AW2526HL)/2560 x 1440 (AW2726DL)**.
4. Click **Keep changes**.

If you do not see 1920 x 1080 (AW2526HL)/2560 x 1440 (AW2726DL) as an option, you must update your graphics driver to the latest version. Depending on your computer, complete one of the following procedures:

If you have a Dell desktop or a laptop:

- Go to [Dell Support Site](#), enter your Service Tag, and download the latest driver for your graphics card.

If you are using a non-Dell computer (laptop or desktop):

- Go to the support site of your non-Dell computer and download the latest graphics card drivers.
- Go to the support site of your graphics card and download the latest graphic card drivers.

Troubleshooting

⚠ **WARNING:** Before you begin any of the procedures in this section, follow the [Safety instructions](#).

Self-test

Your monitor provides a self-test feature that allows you to check whether your monitor is functioning properly. If your monitor and computer are properly connected but the monitor screen remains dark, run the monitor self-test by performing the following steps:

1. Turn off both your computer and the monitor.
2. Unplug the video cable from the computer.
3. To ensure proper self-test operation, remove all digital and the analog cables from your computer.
4. Turn on the monitor.

A dialog box should appear on-screen, indicating that the monitor is working correctly and is not receiving a video signal. While in self-test mode, the power LED remains white (the default color).

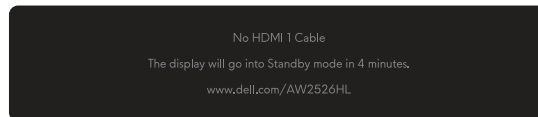


Figure 43. Warning message for no HDMI 1 cable (AW2526HL)

or

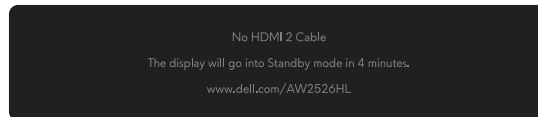


Figure 44. Warning message for no HDMI 2 cable (AW2526HL)

or

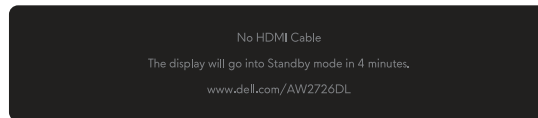


Figure 45. Warning message for no HDMI cable (AW2726DL)

or



Figure 46. Warning message for no DP cable

- ① **NOTE:** The message may vary slightly depending on the connected input signal.
- ① **NOTE:** This dialog box also appears during normal operation, if the video cable is disconnected or damaged.

5. Turn off your monitor and reconnect the video cable; then turn on your computer and the monitor.

After performing the above steps, if the monitor displays no video output, then the problem may be with the graphics card or the computer.

Built-in diagnostics

Your monitor includes diagnostic tools to help you identify whether the screen abnormality or audible noise is an inherent issue with the monitor.

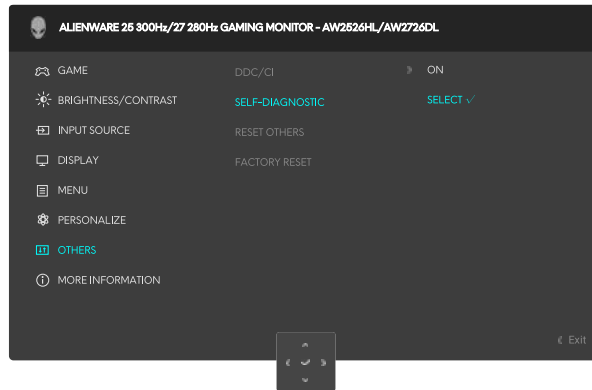


Figure 47. The message of Built-in diagnostics

To run the built-in diagnostics:

1. Ensure that the screen is clean (there are no dust particles on the surface of the screen).
2. Move or press the joystick button to launch the Menu Launcher.
3. Move the joystick button up to select and open the Main Menu.
4. Move the joystick button to navigate and select **OTHERS > SELF-DIAGNOSTIC** from the OSD menu.
5. Press the joystick button to start the built-in diagnostics. A gray screen is displayed.
6. Observe if the screen has any defects or abnormalities.
7. Toggle the joystick button once again until a red screen is displayed.
8. Observe if the screen has any defects or abnormalities.

Repeat steps 7 and 8 until the screen displays green, blue, black, and white colors. Note any abnormalities or defects.

The test is complete when a text screen is displayed. To exit, toggle the joystick button control again.

If you do not detect any screen abnormalities upon using the built-in diagnostic tool, the monitor is functioning properly. Check the video card and computer.

Common problems

The following table contains general information about common monitor problems that you might encounter and the possible solutions:

Table 23. Common problems description.

Common symptoms	What you experience	Possible solutions
Power LED off, no video	No picture	<ul style="list-style-type: none"> Verify that the power outlet is functioning properly using any other electrical equipment. Ensure that the power button is pressed properly.
Power LED on, no video	No picture or no brightness	<ul style="list-style-type: none"> Increase brightness and contrast controls in the BRIGHTNESS/CONTRAST menu. Perform monitor Self-test feature check. Check for bent or broken pins in the video cable connector. Run the built-in diagnostics. For more information, see SELF-DIAGNOSTIC menu. Ensure that the correct input source is selected in the INPUT SOURCE menu.
Poor focus	Picture is fuzzy, blurry, or ghosting	<ul style="list-style-type: none"> Disconnect video extension cables. Reset the monitor to factory settings. For more information, see FACTORY RESET menu. Change the video resolution to the correct aspect ratio.
Shaky or jittery	Wavy picture or fine movement	<ul style="list-style-type: none"> Reset the monitor to factory settings. For more information, see FACTORY RESET. Check environmental factors. Relocate the monitor and test in another room.
Missing pixels	LCD screen has spots	<ul style="list-style-type: none"> Cycle power On-Off. Pixel that is permanently off is a natural defect that can occur in LCD technology. For more information about Dell Monitor Quality and Pixel Policy, see Dell Display Pixel Guidelines.
Stuck-on pixels	LCD screen has bright spots	<ul style="list-style-type: none"> Cycle power On-Off. Pixel that is permanently off is a natural defect that can occur in LCD technology. For more information about Dell Monitor Quality and Pixel Policy, see Dell Display Pixel Guidelines.
Brightness problems	Picture too dim or too bright	<ul style="list-style-type: none"> Reset the monitor to factory settings. For more information, see FACTORY RESET. Adjust brightness and contrast controls in the BRIGHTNESS/CONTRAST menu.
Geometric distortion	Screen not centered correctly	Reset the monitor to factory settings. For more information, see FACTORY RESET .
Horizontal/vertical lines	Screen has one or more lines	<ul style="list-style-type: none"> Reset the monitor to factory settings. For more information, see FACTORY RESET. Perform monitor Self-test feature check and determine if these lines also appear in self-test mode. Check for bent or broken pins in the video cable connector. Run the built-in diagnostics. For more information, see SELF-DIAGNOSTIC.

Common symptoms	What you experience	Possible solutions
Synchronization problems	Screen is scrambled or appears torn	<ul style="list-style-type: none"> Reset the monitor to factory settings. For more information, see FACTORY RESET. Perform monitor Self-test feature check to determine if the scrambled screen appears in self-test mode. Check for bent or broken pins in the video cable connector. Restart the computer in the safe mode.
Safety-related issues	Visible signs of smoke or sparks	<ul style="list-style-type: none"> Do not perform any troubleshooting steps. Contacting Dell immediately.
Intermittent problems	Monitor malfunctions on and off	<ul style="list-style-type: none"> Ensure that the video cable connecting the monitor to the computer is connected properly and is secure. Reset the monitor to factory settings. For more information, see FACTORY RESET. Perform monitor Self-test feature check to determine if the intermittent problem occurs in self-test mode.
Missing color	Picture missing color	<ul style="list-style-type: none"> Perform monitor Self-test feature check. Ensure that the video cable connecting the monitor to the computer is connected properly and is secure. Check for bent or broken pins in the video cable connector.
Wrong color	Picture color is not good	<ul style="list-style-type: none"> Reset all settings under the GAME menu to the factory defaults using RESET GAME. Change the INPUT COLOR FORMAT to RGB or YCbCr in the Display settings OSD. Run the built-in diagnostics. For more information, see SELF-DIAGNOSTIC.
Screen image is too small	Image is centered on the screen, but does not fill the entire viewing area	<ul style="list-style-type: none"> Check the ASPECT RATIO settings in the DISPLAY menu OSD. Reset the monitor to factory settings. For more information, see FACTORY RESET.
You cannot adjust the monitor using the joystick button	The OSD does not appear on the screen	<ul style="list-style-type: none"> Turn off the monitor, unplug the power cable, plug it back, and then turn on the monitor. Check whether the OSD menu is locked. If yes, move and hold the joystick button up/down/left/right for 4 seconds to unlock. For more information, see Locking the control buttons.
No input signal when user presses controls	No picture, the LED light is on	<ul style="list-style-type: none"> Check the signal source. Ensure that the computer is not in the power-saving mode by moving the mouse or pressing any key on the keyboard. Check whether the signal cable is plugged in properly. Replug the signal cable if necessary. Reset the computer or video player.
The picture does not fill the entire screen	The picture cannot fill the height or width of the screen	<ul style="list-style-type: none"> Due to different video formats (aspect ratio), the monitor may display in full screen. Run the built-in diagnostics. For more information, see SELF-DIAGNOSTIC.
Screen flickering	There is some noticeable flickering in the displayed pictures	<ul style="list-style-type: none"> Set your monitor to its native resolution—1920 × 1080 at 60 Hz for AW2526HL or 2560 × 1440 at 60 Hz for AW2726DL—or choose a higher refresh rate. If the variable refresh rate (VRR) of your device is turned on, turn off variable refresh rate (VRR). If you are using an AMD graphics card and Free-Sync is turned on, turn off Free-Sync. Update the graphics card driver and firmware to the latest version. Change the cable connecting the monitor to the computer. A defective cable can cause the signal to break while being transmitted across the wire. Check the surroundings. Electromagnetic fields can cause screen flickering. If there is another device plugged into the same power strip as the monitor, try to remove it.

Common symptoms	What you experience	Possible solutions
Image retention occurs when a static image remains on the monitor for an extended period.	A faint shadow of the static image appears on the screen.	<ul style="list-style-type: none"> • Set the screen to turn off after a few minutes of screen idle time. This can be adjusted in the Windows Power Options or Mac Energy Saver setting. • Alternatively, use a dynamically changing screensaver. • For more information, see Maintenance guidelines.
Unevenness in luminance or color of the screen images	Visible spots (bright or dark) or lines or Mura appear on the screen	
Pixel shifting occurs	The image on the screen moves slightly sometimes.	Pixel shift is a function that moves the pixels of the screen to prevent image retention on VA panels. It does not influence your viewing experience.
Cannot select 10-bit color (AW2726DL)	Unable to select 10-bit color from the connected computer	<ul style="list-style-type: none"> • If your computer is equipped with an NVIDIA graphics card, go to NVIDIA control panel > Resolutions > Output Color Depth, select 10 bpc (bits per color) from the Color Depth dropdown menu, and click Apply. • For your computer is equipped with an AMD graphics card, go to AMD RADEON PRO AND AMD FIREPRO SETTINGS > Display > Color Depth, and select 10 bpc from the drop-down list.

Regulatory information

FCC notices (U.S. Only) and other regulatory information

For FCC notices and other regulatory information, see the [Dell Regulatory Compliance Home Page](#).

EU product database for energy label and product information sheet

For more information about the energy labeling regulations, see the following resources:

- [Energy Labeling Information for AW2526HL](#)
- [Energy Labeling Information for AW2726DL](#)

Contacting Dell

To contact Dell for sales, technical support, or customer service issues, see [Contact Support at Dell Support Site](#).

- ① **NOTE:** Availability varies by country, region, or product, and some services may not be available in your country.
- ① **NOTE:** If you do not have an active Internet connection, you can find contact information in your purchase invoice, packing slip, bill, or Dell product catalog.

Revision History

The following table provides the revision history of this document:

Table 24. Revision history

Revision	Date	Description
A00	January 2026	Original publish date